



**THE CORPORATION of the UNITED TOWNSHIPS of HEAD, CLARA & MARIA**  
**AGENDA**

Thursday, September 17, 2020 at 1:00 p.m.

1. Call to Order and Moment of Silence  
*Let us take a moment of silent reflection to contemplate in our own way the responsibility we have to collectively use our skills and experience to ensure the mutual long term benefit of our Municipality and those we represent.*
2. Roll Call
3. Recital of the Municipal Mission and Vision Statements
4. Disclosure of Pecuniary interest & General Nature Thereof
5. Deputations/Presentations
  - Hendrik Vanderhorn – Sandpit
6. Adoption of Minutes of previous meeting
  - Council Minutes
    - i. August 22<sup>nd</sup>, 2020
  - Library Board Minutes
    - i. September 2<sup>nd</sup>, 2020
  - Recreation Committee Minutes - none
  - Public Works Advisory Committee Minutes
    - i. None – road tour occurred on September 10<sup>th</sup>
7. Petitions and Correspondence  
Information Only – (Please advise if you feel any item warrants further consideration)
  - i. Emancipation Day – City of Elliot Lake
  - ii. Security from Trespass Act – Ministry of Agriculture, Food and Rural Affairs
  - iii. Tax Sale Process Resuming – RealTax
  - iv. Clerk Treasurer Enrollment in Investments 101 – Municipal Investing – AMO
  - v. HHW Mobile Activity Report – DrainAll
  - vi. Bill 197 Information Session Presentation - MMAH
8. Mayor's Report
  - Report 20/09/17/801 – Mayor Debbi Grills
9. Staff Reports
  - None
10. Unfinished Business –
  - Report 20/09/17/1001 – Streetlights
11. Addendum (New Business)
  - Report 20/09/17/1101 – Haines Severance
  - Report 20/09/17/1102 – IT Contract
12. By-Laws – none
13. Questions and Answers
14. Confirmation of Proceedings By-law # 2020-14

15. Adjournment

Note\* Alternate formats and communication supports are available on request.

---

HCM Mission: At your service; working effectively to bring together people, partnerships and potential for a strong, connected community.

HCM Vision: Providing a healthy, connected, and sustainable community teeming with possibilities for our citizens now and into the future.



THE CORPORATION OF THE UNITED TOWNSHIPS OF  
**HEAD, CLARA & MARIA**  
15 Township Hall Road  
STONECLIFFE, ONTARIO, K0J 2K0

Phone: (613) 586-2526 | Fax: (613) 586-2596 | E-mail: [clerk@headclaramaria.ca](mailto:clerk@headclaramaria.ca)

**REQUEST FOR DEPUTATION**

Person Requesting a Deputation: Hendrik van der Horn  
Organization (if applicable): n/a  
Contact Information: Tel # 613 853 5071 Email: vanderhorn@rogers.com  
Meeting Date Requested: Sept 17/20  
Subject Matter: sand pit 181 Plains Camp Rd.  
Brief Description of Purpose of Deputation: To find out if township would consider entering into contract for proposed sand pit at 181 Plains Camp.

Have you been in contact with a member of staff with regard to this matter?

Yes  No  If Yes, provide name: unsure of names

I will have a presentation ... verbal explanation.

For Handout at Meeting \* Yes  No

PowerPoint \*\* Yes  No

(I will require use of a \_\_\_ computer, \_\_\_ projector, and \_\_\_ screen.)

\* Handouts require six (6) copies to be provided to the Clerk **prior** to the meeting.

\*\* PowerPoint is to be e-mailed to the Clerk's Office no later than 12:00 Noon on the Friday **prior** to the meeting. Any speaking notes should be provided to Council for its record.



## Head, Clara and Maria Public Library Board Meeting Minutes

A Regular Meeting held on **2020, June 17** was called to order at 10:00 a.m.

### 1. Roll Call

Designation	Name	P	A	E	Designation		P	A	E
Chair	Marlene Gibson	X			Member	Gay Baribeau	X		
Member	Catherine Sutherland	X			Member	Fran Kelly - Chamberlain	X		
Member	Betty Condie	X			CEO	Judy Zilney	X		

### 2. Pecuniary Interest: None

### 3. Approval of Agenda:

**Resolution #1:** Moved by Fran Kelly-Chamberlain, Seconded by Catherine Sutherland. Be it resolved that the agenda for June 17, 2020 be accepted as presented. CARRIED

### 4. Approval of Minutes of Previous Meeting:

**Resolution #2:** Moved by Fran Kelly-Chamberlain, Seconded by Catherine Sutherland. Be it resolved that regular minutes for March 10, 2020 be accepted as presented. CARRIED

- 5. Business Arising from the Minutes:** Introduce separate revenue and expense accounts for the Open Sesame and Bowtie Classic fundraisers instead of grouping them in the 51-6110 Fundraising Events account. Research the possibility of reducing bank account charges. Our next financial statement will have the separate accounts listed. The bank account charges are in line with a corporate account. Care is taken to combine receipt for submission to result in one payout to keep the charges as low as possible.

### 6. Circulation Report for March 2020

Type	Amount
DVDs/CD	6
Junior Fiction/YA	2
Adult	13
Periodicals	
Total Circulation	<b>21</b>

The Annual Survey has been completed and submitted.

Due to the COVID\_19 pandemic instructions our library closed on March 16. There has been no activity since then. We are now setting up Curbside pickup for patron access.

A meeting of 35 library reps was held on June 11 to discuss curbside pickup, sanitation procedures, and library computer access throughout our region.

The 2019 Library Annual Report will be submitted to the Township as an addition to the next Municipal Newsletter.

**7. Report of The Chair:**

Marlene thanked everyone for coming out to the social distancing meeting. She gave a report of the funds she submitted in the amount of \$125 which resulted from the sale of food items destined for the Spring Card Party which was cancelled.

**8. Financial Reports:**

**The Income Statement** for the period from 2020-01-01 to 2020-06-30, printed June 17,2020 was reviewed.

**Resolution #3:** Moved by Betty Condie, Seconded by Fran Kelly-Chamberlain that the Income Statement be accepted as presented. CARRIED.

**9. Correspondence:** Southern Ontario Library Service and the Ontario Library Services North recommendation to proceed with the merger of the two entities has been approved by both boards. A Joint Transition Committee to negotiate the Amalgamation Agreement has been formed. This agreement will be presented in the fall of 2020 for approval with the goal of the new amalgamated organization to be up and running by April 1, 2021.

**10. Policies:** None at this time.

**11. New Business:**

**Budget redo.** The 2020 budget has been redone to address the changes COVID-19 has had to our operation. The topic of the amortization was discussed with followup information at the next meeting

**Curbside pickup.** A procedure where Book/DVD reservations would be made by calling Marlene Gibson for a designated pickup date.

The items would be placed in a paper bag with a note stating items and the return procedure on a designated date using the same bag. These items will be placed in the trunk of the vehicle by library staff wearing a mask and using hand sanitizer.

The items will be returned and placed in a quarantine of 72 hours as designated by public health.

Delivery in special circumstances is available.

**Volunteer Appreciation.** Volunteer Appreciation will be acknowledged by a card containing a \$10.00 Canadian Tire gift certificate sent out to each volunteer. A poster containing the volunteer names will be posted in the library.

**12. Reports of Projects:** Betty Condie, our resident horticulturalist, had planted many assorted plants for the Library annual June Jazaar. Because our June Jazaar was cancelled, Betty held the sale at her home by appointment resulting in revenue of \$1033.00. Much appreciation to Betty for her efforts.

**13. Questions and Answers:** We will hold meetings in September, October and November during the COVID-19 times.

**14. Action Items:** Catherine Sutherland to develop a poster containing curbside pickup instructions as well as the poster containing the volunteer names. Marlene Gibson will look after cash cards for volunteer appreciation. Judy Zilney to get the Thank you cards, fill them in and mail them.

**15. Adjournment:** **Resolution # 4:** It was moved by Betty Condie, Seconded by Fran Kelly-Chamberlain that the meeting be adjourned at 12:15 p.m. to meet again on Tuesday, September 8, 2020 at 10:00 a.m. CARRIED.

---

Chair – Marlene Gibson

---

CEO – Judy Zilney

**THE CORPORATION OF  
THE CITY OF ELLIOT LAKE**

**CERTIFIED TRUE COPY**

Moved By: T. Turner  
Seconded By: L. Cyr

THAT the City of Elliot Lake Council acknowledges and supports the following Private Member Bill put forward by Majid Jowhari: M-36, Emancipation Day, 43rd Parliament, 1 Session that reads as follows:

"THAT the House recognizes that:

The British Parliament abolished slavery in the British Empire as of August 1, 1834;

Slavery existed in the British North America prior to the abolition in 1834; Abolitionists and others who struggled against slavery, including those who arrived in Upper and Lower Canada by the Underground Railroad, have historically celebrated August 1st as Emancipation;

The Government of Canada announced on January 30, 2018 that it would officially recognize the United Nations International Decade for people of African Descent to highlight important contributions that people of African descent have made to Canadian society, and to provide a platform for confronting anti-Black racism;

The heritage of Canada's peoples of African descent and the contributions they have made and continue to make to Canada and in the opinion of the House, the Government should designate August 1 of every year as "Emancipation Day" in Canada; and

THAT support for this motion be sent to the Member of Parliament for Algoma and all House of Commons representatives; and

THAT support for this motion be sent to all municipalities in Ontario.

Resolution No. 249/20 Carried Mayor Dan Marchisella



**Certified True Copy.**

*Mattie Bray*

City Clerk August 14, 2020



Ministry of Agriculture,  
Food and Rural Affairs

Office of the Minister

77 Grenville Street, 11th Floor  
Toronto, Ontario M7A 1B3  
Tel: 416-326-3074  
www.ontario.ca/OMAFRA

Ministère de l'Agriculture, de  
l'Alimentation et des Affaires rurales

Bureau du ministre

77, rue Grenville, 11<sup>e</sup> étage  
Toronto (Ontario) M7A 1B3  
Tél. : 416 326-3074  
www.ontario.ca/MAAARO



August 31, 2020

Ms. Crystal Fischer  
Acting Clerk  
United Townships of Head, Clara and Maria  
crystal@headclaramaria.ca

Dear Ms. Fischer:

Over the past 2 years, our government has heard from farmers, municipalities and the broader agriculture community about the threat of on-farm trespass activities. We have heard that farmers are worried for their own safety, the safety of their families, their employees as well as the safety of their animals.

We listened to your concerns, and back in December 2019, I was honoured to introduce the [Security from Trespass and Protecting Food Safety Act, 2020](#) and to act on our government's commitment to protect farmers, agri-food businesses, farm animals and our food supply from the risks of trespass activities. The Act received Royal Assent on June 18, 2020.

I appreciate the strong support that I have received from our stakeholder partners, like you, on such an important piece of legislation. The COVID-19 outbreak has shown us now more than ever, how important it is to have a steady, reliable food supply and to protect the health and safety of the agri-food workers who help feed us.

As you may be aware, we have recently seen a public safety situation grow more urgent. Earlier this summer a demonstrator tragically died outside a meat processing plant. Since then, we have seen heightened tensions leading to greater risks for everyone involved. This has created a significant public safety concern that must be addressed to ensure everyone's safety.

As a result, I am announcing today a partial proclamation of the [Security from Trespass and Protecting Food Safety Act, 2020](#) that will come into effect on Wednesday September 2, 2020 at 12:01AM to address these immediate public safety concerns.

.../2

We are proclaiming sections 6(1), 7, 14(1)[3] and 15(1) of the Act, making it an offence to stop, hinder, obstruct or otherwise interfere with a motor vehicle transporting farm animals.

Regulation 950 under the [Provincial Offences Act \(POA\)](#) is also being amended so that tickets can be issued under Part I of the POA for a contravention of section 6(1) of the Act. This approach will allow for more immediate use of the relevant provisions to address the obstruction of motor vehicles transporting farm animals.

I am also pleased to inform you that a [Discussion Paper](#) has been posted on the regulatory registry, outlining the ministry's proposed approach for the regulatory items that are needed to make the rest of the Act come into force. It will be posted for public comment for 45 days, closing on October 15, 2020. Comments can also be sent directly by email to [SecurityFromTrespass.OMAFRA@ontario.ca](mailto:SecurityFromTrespass.OMAFRA@ontario.ca).

I understand the importance and urgency of this Act to many across the sector. However, before the remaining sections can be proclaimed into force, a number of items must be prescribed via a regulation to operationalize the Act. These regulations are needed to ensure the act is clear, easily interpreted and fulfils its intended purposes. It is important that we take the time to hear from those impacted so we can take those comments into consideration in finalizing the regulation.

The remaining sections of the Act come into force upon proclamation by the Lieutenant Governor in Council. Once fully proclaimed into force, the Act will recognize the unique risks associated with trespassing on farms and at processing facilities.

I strongly encourage you to provide feedback and comments on this discussion paper. Your insights are valuable as we work to ensure the Minister's Regulation and the Act are fair and reasonable while also meeting the needs of industry. Your input is an important contribution to help shape the content and design of the Minister's Regulation.

Again, thank you for your support. I look forward to working with you to create a safe and healthy Ontario for all.

Sincerely,

A handwritten signature in black ink, appearing to read 'Ernie Hardeman', written over a white background.

Ernie Hardeman  
Minister of Agriculture, Food and Rural Affairs

## HCM Clerk-Treasurer

---

**From:**Carolynn Kent - Realtax <carolynkent@realtax.ca>  
**Sent:**August 6, 2020 1:06 PM  
**To:**HCM Clerk-Treasurer  
**Subject:**Reg. 73/20 Lift Date

**Follow Up Flag:**Follow up  
**Flag Status:**Flagged



### Reg. 73/20 Lift Date

Dear Clients;

We would like to update you on the status of O.Reg. 73/20 (amended by 106/20).

As of today's date, there has been **no** change to the lift date of this regulation. This means that as of **September 11, 2020** the freeze resulting from this legislation will be lifted and you can commence with tax registration and tax sale processes.

As mentioned in our latest webinar, you will be receiving a summary of files **IF** your files' deadline dates have been affected by this freezing. We will be sending those to you as close to the September 11th date as possible.

As a reminder, we are still offering our "Head Start" option if you would like us to get a head start on NEW files before the freeze has been lifted. Please contact us if you are interested in that option.

Thank you for your continued patience and support.

Carolynn Kent  
Operations Manager  
1-888-585-7555 Ext. 35  
fax: 1-888-853-5885  
[www.realtax.ca](http://www.realtax.ca)

Realtax Inc., [www.realtax.ca](http://www.realtax.ca), Newmarket, Ontario Canada

[SafeUnsubscribe™ clerk@headclaramaria.ca](mailto:SafeUnsubscribe™_clerk@headclaramaria.ca)

[Forward this email](#) | [Update Profile](#) | [About our service provider](#)

Sent by [carolynnkent@realtax.ca](mailto:carolynnkent@realtax.ca) powered by



Try email marketing for free today!

## HCM Clerk-Treasurer

---

**From:** ONE Investment <ONE@oneinvestmentprogram.ca>  
**Sent:** August 19, 2020 3:01 PM  
**To:** HCM Clerk-Treasurer  
**Subject:** COVID-19 Emergency Funding – ONE Investment Options

[HOMEPAGE](#) | [PRIVACY POLICY](#)

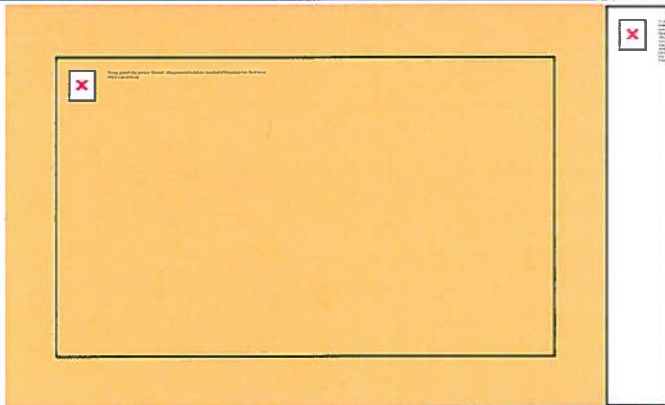

## MUNICIPAL INVESTOR UPDATE

News, tips and expertise on investing specific to the municipal sector

**August 19, 2020**

### **Ontario Municipalities Emergency Fund**

On August 12, 2020 the Ontario government announced Ontario's 444 municipalities would receive one-time emergency assistance to respond to COVID-19 and deliver the critical services people rely on every day. As per the provincial directive, municipalities can place funds in reserves and invest the funding, if not all is needed this year. While your municipality determines allocation for these funds, the ONE Investment HISA account can be utilized to obtain the best interest rate for every dollar invested; ONE does that by aggregating all investor deposits. For further details on this account, [click here](#).

---

### **Online Training - Coming Soon (September 1st to December 2020)**

Learn at your Pace from your Place in 2020. To register for the course, please click here: [Investments 101 - The Foundation for a Municipal Investment Strategy](#).

New and updated content this year that helps municipal staff develop an understanding of the fundamentals of investing. The course will also outline how ONE provides municipalities

with access to investments under the legal list and prudent investor standard. For course inquiries, please contact [one@oneinvestment.ca](mailto:one@oneinvestment.ca) or our Client Service Representative - Wardah Mir at 416-971-9856 x 351.

Email not displaying correctly? [View it in your browser.](#)

[Unsubscribe](#)





## AMO

### Order Information

Order # 202009090003  
 Order Date Sep 9, 2020 9:18:10 AM  
 Order Type Purchase  
 Payment Status Paid  
 Paid Date Sep 9, 2020 9:23:31 AM  
 Payment Method Moneris  
 Transaction ID 660744110017820010  
 Purchase Type This purchase is for me  
 (My Learning Plan)

### Purchaser Information

Charlotte Toope  
 clerk@heeadclaramaria.ca  
 15 Township Hall Rd  
 Stonecliffe, ON, Ontario, K0J2K0  
 Canada

Learning Path	P
Investments 101 - The Foundation for a Municipal Investment Strategy	\$22!

<b>Subtotal</b>	<b>\$22!</b>
<b>HST (13%):</b>	<b>\$2!</b>
<b>Total</b>	<b>\$25!</b>



**Drain-All**

Napanee Operations - [www.drainall.com](http://www.drainall.com)  
444 Advance Ave., Napanee, Ontario, K7R 3Z6  
Tel: (613) 354-9393 / 1-800-265-3868 Fax: (613) 354-9076

**HHW MOBILE ACTIVITY REPORT**

DATE: August 22, 2020 OPEN: 8:30 AM CLOSE: 12:30 PM

MUNICIPALITY: 67 Kenny Rd., Mackey

NUMBER OF VEHICLES: 65 NUMBER OF HOUSEHOLDS: N/A

**WASTES RECEIVED**

MOE CODE	VOLUME	MOE CODE	VOLUME
145	1,000 L	242	100 L
146	50 Kg	252	200 L + 100 Kg
147		263	1,400 L
148	100 L + 100 Kg	312	
212	200 L	331	900 L
221	200 L		
Recycled Plastic	50 Kg		

CAR BATTERIES	9
PROPANE TANKS	
LARGE	22
SMALL	100

**COMMENTS**

A large number of vehicles with waste attended this event. Total volume of household hazardous waste that was diverted from the Township of Head, Clara & Maria to a MOE licensed facility was 4,100 liters and 250 Kg plus car batteries and large propane tanks.

NAME: STEVE TEBWORTH

SIGNATURE



## Bill 197 – Overview

# Ministry of Municipal Affairs and Housing Municipal Information Sessions

August 27, 2020

### Important Notice

- The information in this presentation deals in a summarized fashion with complex matters and reflects legislation, policies and practices that are subject to change.
- The examples and links listed are the responsibilities of the municipalities or persons who implemented them.
- This information should not be relied upon as a substitute for specialized legal or professional advice in connection with any particular matter and should not be construed as legal or professional advice by the Ministry of Municipal Affairs and Housing. The user is solely responsible for any use or the application of this information.

# Session Overview

The following topics will be covered during the presentation:

1. Building Code Act
2. Community Benefits Charges and Related Matters
3. Enhanced Minister's Zoning Order
4. Provincial Land and Development Facilitator
5. Electronic Participation at Meetings
6. Proxy Votes

Ontario 

## Building Code Act

# Building Code Act Amendments

- Amendments include:
  - Convert regulation making authority from Lieutenant Governor in Council (LGIC) to Minister of MMAH
  - Clarify the ability to adopt national construction codes by reference
  - Establish regulation-making authority to require certain aspects of building construction to be designed by professional engineers or architects
- Changes will:
  - Improve Province's ability to respond to urgent public safety or other building-related issues
  - Help Province meet obligations for timely adoption of future editions of National Construction Codes, reduce barriers to trade and help keep cost of construction affordable
  - Bring Building Code in line with how changes are made to the Ontario Fire Code



Ontario 

## Community Benefits Charges and Related Matters

# Development Charges

- Changes to the *Development Charges Act* expand the list of eligible services funded through development charges to provide cost certainty and maintain municipal revenues (see next slide)
- The changes restore most former soft services back to the development charge regime (e.g. services formerly collected through development charges)
- There are no legislative requirement to discount the eligible growth-related costs for these services

## Development Charges Soft Services

Soft services subject to the development charge regime:



# Community Benefits Charges and Related Measures - Overview

- A new framework has been implemented for:
  - Community Benefits Charges;
  - Development Charges; and,
  - Parkland Dedication
- The new framework enhances transparency and certainty with respect to the costs of development
- Municipalities have two years from the date that the community benefits charge regulation comes into effect to transition to the new framework if they choose to do so

Ontario 

## Community Benefits Charges

- Community Benefits Charge (CBC) provisions have been amended under the Planning Act in order to increase cost certainty and provide municipalities with the flexibility to enable growth to pay for growth
- The CBCs apply only to higher density residential development
  - E.g. buildings with 10 or more residential units and 5 or more storeys.
- CBCs are permitted to be levied by single and lower-tier municipalities to fund the capital costs of any service that is attributable to growth if not being recovered through another mechanism (e.g. development charges)

Ontario 

## Parkland Dedication

- Transparency and accountability increased by the new parkland provisions
- Enables municipalities to use both the parkland dedication provisions and community benefits charges in respect of the same development
- Introduces an appeal mechanism for parkland by-laws
  - content relating to the alternative rate would be appealable to the Local Planning Appeal Tribunal (LPAT)

Ontario 

## Enhanced Minister's Zoning Order

# Enhanced Minister's Zoning Order (MZO)

- Amendments to the Planning Act
- New authority can remove potential barriers and expedite planning approvals
- May remove municipal use of site plan control
- May require agreements between municipalities and proponents on site plan matters
- May be used to require inclusionary zoning and thereby set affordable housing requirements (e.g., number of units, affordability, duration etc.)
- May be amended without providing advance notice
- Can not be used in the Greenbelt Area (all lands included in Niagara Escarpment Plan, Oak Ridges Moraine Conservation Plan, Greenbelt Plan Protected Countryside and Urban River Valleys)

Ontario 

## How does the enhanced MZO work for site plan?

- It removes the ability for the municipality to use its site plan control authority under the Planning Act, but the Minister may instead require the proponent to enter into an agreement with the municipality to address matters typically dealt with through site plan
- Where an agreement is required, the municipality continues to lead the discussion and negotiation with the proponent on site plan matters and the development of the agreement
- The Minister can provide written direction to the proponent and the municipality on any site plan matters, such as walkways, lighting, landscaping, and the site plan agreement must comply with this direction.
- Like other MZOs, the site plan agreements or the Minister's direction on the agreements cannot be appealed to the Local Planning Appeal Tribunal (LPAT)

Ontario 

# Provincial Land and Development Facilitator

## Provincial Land and Development Facilitator

- The office of the Provincial Land and Development Facilitator (PLDF), which has existed in various forms for many years as an advisory body, has been permanently established in legislation. The essential role of the PLDF is unchanged
- The Minister will appoint one person as the PLDF, establish a terms of reference and continue to provide direction on the matters in which the Facilitator becomes involved
- Through the PLDF, the government will take a leadership role and work collaboratively with both municipalities and stakeholders to explore all opportunities to stimulate the economy
- The PLDF will also provide objective, confidential and independent advice to the Minister, which can be used to resolve complex challenges on provincial priority projects, unlock and accelerate land development, and create jobs



# Electronic Meetings

## Electronic Meetings - Overview

- Amendments to the Municipal Act allow for electronic meetings at all times and permit electronic participation to count towards quorum
- Applies to councils, committees and certain local boards
- Provisions are optional
- Municipalities may wish to review their procedure by-laws to determine whether to take advantage of the new provisions

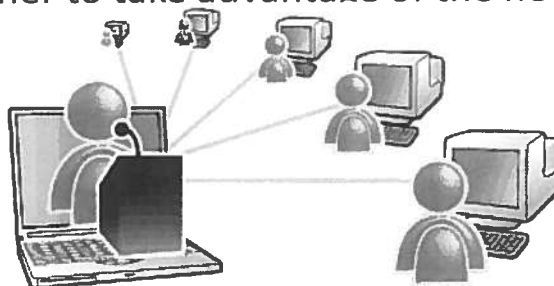

# Electronic Meetings – What a Municipality Can Do

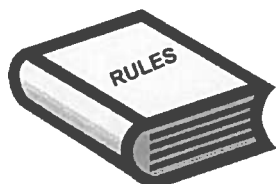

- Procedure by-laws can be amended to:
  - Allow the use of electronic participation at meetings
  - State whether members can participate in open and closed meetings electronically
  - State whether members participating electronically can be counted towards quorum
- Municipalities have the flexibility to determine:
  - Whether to use these provisions
  - The method of electronic participation
  - The extent to which members can participate electronically
- Municipalities can choose the technology best suited to their local circumstances
- Municipalities may choose to hold a special meeting electronically to amend their procedure by-law

Ontario 

# Electronic Meetings – Open Meetings and Rules for Local Boards

- Meetings would still be required to follow existing meeting rules, including:
  - Notice provisions
  - Maintain meeting minutes
  - Continue to hold meetings open to the public (subject to certain exceptions)
- Examples of local boards subject to the meeting rules include:
  - Municipal services boards
  - Transportation committees
  - Boards of health
  - Planning boards
- Examples of local boards not covered include:
  - Police services boards
  - Library boards
  - School boards

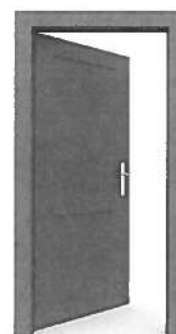

Ontario 

# Proxy Voting

## Proxy Voting – Overview

- Amendments to Municipal Act
- Municipalities have flexibility to choose to allow proxy votes for council members who are absent from meetings
- Municipalities can amend their procedure by-law if choosing to take advantage of this flexibility
- If a municipality chooses to use proxies, it is the role of the clerk to establish a process for appointing and revoking proxies

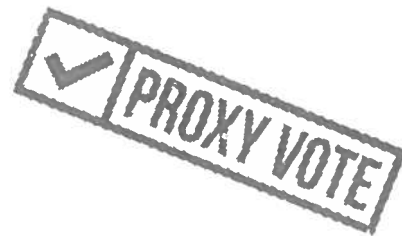

## Proxy Voting – Optional and Flexible

- Allowing proxy voting is optional
- Councils have flexibility to determine scope and extent of proxy appointments, subject to certain limitations
- Proxy can be revoked
- Considerations for municipalities include:
  - How proxies may be established and revoked
  - Circumstances where proxies may or may not be used
  - How a proxyholder may participate in a meeting including voting, speaking or asking questions on behalf of the appointing member
  - Amending code of conduct or other policies to help ensure votes are appropriately cast

Ontario 

## Proxy Voting – Limitations

- Municipal Act provides for certain limitations:
  - Proxyholder must be member of same council
  - A Member cannot be proxyholder for more than one other member at the same time
  - Appointed proxy is not counted towards quorum
  - Member appointing a proxy shall notify the clerk of the appointment
  - During recorded votes, clerk shall record name and vote of every proxyholder and name of member proxyholder is acting for
- Council member absence rules still apply
  - A member's seat would become vacant if absent from meetings for 3 successive months without approval of council by resolution

**LIMITS**

Ontario 

# Proxy Voting – Accountability and Transparency

- Existing accountability and transparency requirements apply
  - E.g. Municipal Conflict of Interest Act



- Additional accountability and transparency considerations:
  - Communicate to the public about the use of proxies
  - Publish meeting agendas in advance to permit time for proxies to be appointed
  - Allow members to participate electronically when not able to attend in person
  - Consult the Municipal Councillor's Guide for more information on accountability and transparency

## Mayor's Report – Thursday September 17, 2020

It is a pleasure to welcome our visitors in the public gallery this afternoon.

It has been 4 weeks since our last council meeting. At that meeting the question of ownership of the Algonquin Trail was raised. I directed this question to Craig Kelley of the Development and Property department that oversees the Algonquin Trail Advisory Committee (ATAC). His response was as follows:

*“Simply put, we haven’t transferred all of the property parcels yet.*

*In HCM, several of these parcels transverse through Crown Land and will take a severe process to get these surveyed and conveyed to the County.*

*In the meantime, we have a long-term lease with CP for lands that we will own, and are able to treat like they are ours.”*

At the County Council Zoom meeting on August 26<sup>th</sup>, we were presented with a Current State Assessment from Strategy Corp. of the COR Service Delivery review. The interim report noted that Renfrew County has a strong financial position; leadership and culture across the County is a major strength and there is some lack of consistency across local municipal partners in terms of service delivery priorities. In one area of further exploration of shared services, it was suggested that a regional discussion on waste management be facilitated. Councillors from various local municipalities voiced opinion that fire protection might be an area that should also be explored.

On September 4<sup>th</sup>, we said farewell to our summer student, Sneh Patel. He has been a welcome addition to our municipal office during these last 2 summers and we wish him continued success as he returns to Queens University for his third year. This summer we were able to fund this entire additional salary with the federal government’s Canada Summer Student grant.

On September 9<sup>th</sup> I attended both Health and Social Services Committees Zoom meetings. The Assessment Centres are still awaiting promised funds from the Ontario government. The paramedic service is working toward an indoor model for COVID-19 testing as the seasons change. The upcoming flu season will put an additional pressure on our health services and it is hoped that the County of Renfrew paramedic service can initiate a one window approach for flu vaccine & COVID testing. It was also noted at the DRDH Mayors’ meeting on September 10<sup>th</sup> that RC Public Health is looking for help with the delivery of immunization clinics. It is anticipated that clinics could be hosted in late October/November in a large indoor site. I expect more information to follow by the end of the month. I hope that HCM can host a clinic for our residents in this hall.

Long Term Care continues to report significant staffing shortages. Many nursing students have gone back to school and cannot return to weekend work as it requires 14-day isolation and screening. LTC residents are again able to leave the facility for overnight visits with family. On return, this presents a concern for other residents and additional testing and workload for LTC home staff.

This past weekend the County of Renfrew’s paramedic service and the RC VTAC was highlighted on the CBC radio program “White Coat, Black Art” as the rural solution to hallway medicine. Another upcoming program is to follow outlining how the COR paramedic service also provides in home palliative care.

The program can be found at the following link:

<https://www.cbc.ca/listen/live-radio/1-75-white-coat-black-art/clip/15797595-a-local-solution-global-pandemic-how-covid-19-lit>

I was pleased to join the Public Works Advisory Committee (PWAC) roads tour on September 10<sup>th</sup>. The tour led by Chairman Ernie Villeneuve began in Deux Rivieres and not only included roads but expanded to the salt shed; Lacroix Park and boat launch; 2 cemeteries; a closed waste disposal site in Deux Rivieres; Bissett Creek waste disposal site and culverts on Adelard Road. Although we did not manage to see the entire road system yet, we did acquire a new knowledge and understanding of our community and some of its folklore. My thanks to the following members of the committee: Andy Boissonneau, David Balla-Boudreau, Jim Gibson, Pat McGurran and Administrative Assistant Stephany Rauch and Clerk-Treasurer Charlotte Toope for their time and expertise. I am looking forward to completing our tour in Stonecliffe and Mackey, as Part 2 will take place tomorrow September 18<sup>th</sup>.

Mayor Debbi Grills

United Townships of Head, Clara & Maria Council

Request for Decision

Type of Decision									
Meeting Date	Thursday, September 17, 2020				Report Date	Wednesday, September 11, 2020			
Decision Required	X	Yes		No	Priority	X	High		Low
Direction	X	Information Only			Type of Meeting	X	Open		Closed
<b>Report #20/09/17/1001 – Streetlights</b>									

**Subject:** Streetlights options for municipality

**Recommendation:** Continue with pursuing electric street lights for municipality.

**Background/Executive Summary:**

At the August 22, 2020 Council Meeting, the Clerk-Treasurer was directed to gather information regarding the feasibility of electric vs solar powered streetlights.

Information we have received on solar streetlights is attached as well as a report on current progress on installation of electric lights.

**Financial Considerations/Budget Impact:**

Unable to give an accurate reflection of costs at this time.

**Enclosures:**

- Clear Blue Solar Street Lights Presentation
- Report on electric streetlight progress

Approved and Recommended by the Clerk
Charlotte Toope, Clerk/Treasurer



Revised report to reflect visits with Ontario Hydro representatives ( [REDACTED] on Thursday March 12th) and ( [REDACTED] on Wednesday September 2<sup>nd</sup>) to 6 township road locations.

Purpose of these visits was to determine the possibility of installing street lighting at locations that were deemed to be a safety concern.

General requirements\inspection outcomes:

- 1) A MTO Encroachment Permit will be required for each chosen location. A search on the internet and follow up phone call confirmed that these lights would be classified as a Commercial/Municipal Utility on Highway Right of Way. The cost is \$1560 each (permit valid for 10 years). It is a one-time fee, and after 10 years it would need to be renewed. The responsible person to review the permit is [REDACTED] who works in the Ottawa office and is responsible for MTO between Petawawa and Mattawa. The process requires that we submit each application with a photo and a description of the exact location at which point a representative from MTO Traffic Review would come and verify the proposed location, and if approved then the permit fee would then be required. Additionally, a special environmental review of the MTO corridor between Petawawa and Mattawa is planned subject to restrictions from Covid-19 for the MTO employees. Jodi [REDACTED] also advised that in some instances e.g. Dunlop Crescent where Hydro would be adding a transformer to an existing pole located on highway right of way that they also would need an encroachment permit which would cost HCM an extra \$1560. Note also that the respective costs for an encroachment permit may have gone up in the last 6 months.
- 2) In order to install these lights 'secondary power' is required. Presently there is no 'secondary power' at Dunlop Crescent, McIssac Road, Jennings Road, Mackey Creek Road or Harvey Creek Road. This means that Hydro would have to install a transformer on a pole close to the chosen location. It has not yet been confirmed that Hydro will do this installation when the end use is a single light. [REDACTED] [REDACTED] did make a quick call and it appears that Hydro still does do this, however he took an action to confirm for sure and get back to me. Note that I did not hear back from [REDACTED] (who has now retired) on this question, however [REDACTED] did not see an issue for Hydro to install these transformers. Additionally, on Jennings Road Hydro would need to replace an existing pole to install the transformer which would add 3-4k to the total cost for that location.
- 3) Hydro expects that the townships would hire a Contractor to install all the poles and lights, run the wire (underground if possible as going overhead may require that an anchor be installed on the lamp pole which in some cases could be an impediment for local ATV traffic) and leave sufficient wire to go up the pole and make the connection. [REDACTED] suggested [REDACTED] of Douglas ([REDACTED]) as a reliable Contractor for this scope of work in HCM. [REDACTED] also suggested that we contact Petawawa Electric as they are now doing some of this type of pole installations/set-up. A separate visit to each site would be required with the chosen Contractor in order to finalize the exact location and estimated cost.

- 4) Based on this most recent visit (without the snow cover) the following are my findings (going west to east):
- i) Dunlop Crescent (west end entrance): Use the existing transformer across the highway, come overhead to the new pole ensuring sufficient height over the highway for clearance of traffic/transport. The new pole may need to be a tall one to clear the traffic, and an anchor may be needed;
  - ii) McIsaac Road: The location would now have to be on the east side of the entrance as on the west side there is a culvert and an extensive rock covered ditch. A transformer would be required and the connection would have to be made overhead which may also require an anchor on the lamp pole;
  - iii) Jennings Road: There is still the need for a transformer and likely a new pole, although (depending on the cost) it might be beneficial to go underground to the lamp pole as there is a possibility of interference with overhead connection to the lamp pole and existing power across the highway, and overhead connection may require an anchor;
  - iv) Mackey Creek Road: Installation would be from an existing pole (with new transformer) and consider going underground to ensure no need for an anchor post and not to be a factor for the obvious ATV path;
  - v) Boudreau Road: This would be the easiest installation (although the lamp pole would be on the east side of the roadway) as an underground connection could be made to the pole close by to [REDACTED] garage. On the west side of the road there is a high potential for conflict with the snow plow path and ATV traffic. This would be the easiest installation due to the already existing secondary power, although this is clearly the lowest priority from a safety perspective;
  - vi) Harvey Creek Road: This is a change from the previous plan in that power would have to come from an existing pole on the other side of the highway. A new transformer would be needed) which could lead to an additional encroachment fee) and the overhead line would need to be sufficiently high to clear traffic i.e. a tall pole would likely be needed, and perhaps an anchor.
- 5) I have placed a flag with yellow and red flagging tape at each suggested location however [REDACTED] advised that MTO have clear directives on distance from center line of the highway as well as distance from the closed paved edge of the township roads for the placement of these lamp poles. This information needs to be obtained from MTO and then we need to revisit the placement of the proposed poles. At that point photos taken to go with the applications for the individual Encroachment permit. If we have this information from MTO we could confirm the exact pole locations during the planned road visit of September 10<sup>th</sup>. I have already taken photos of each site, however I will keep them at this time until the proposed locations are confirmed as correct.
- 6) Actions going forward (based on input from [REDACTED]) are:
- a) Determine exact pole proposed location based on MTO distance regulations;
  - b) Visit the site with the Contractor (who apparently are quite busy, and this action may take a longer time than we have) to review the plan and get estimates for each site;
  - c) Contact Hydro (BCC section) to get an approved layout; and
  - d) Finally apply to MTO for the individual encroachment permits.

# Illumient Proposal

**Client: Township of Head, Clara & Maria**

**Contact: Stephany Rauche**

**Project Name: Lighting**

**Quote#: 2019-0920**

**Presented by: Marlee Cittadino**



**Quote valid for 60 days**



**CLEARBLUE**  
TECHNOLOGIES

**ILLUMIENT**  
Smart Off-Grid Lighting

# About Clear Blue / Illumient

BEFORE THE SALE 	INSTALLATION 	ONGOING
<ul style="list-style-type: none"> <li>• Site lighting and power analysis</li> <li>• Configured to local conditions – never undersized</li> <li>• Quality components               <ul style="list-style-type: none"> <li>• Extensive options</li> <li>• Decorative &amp; industrial poles, color choices</li> <li>• Solar / Wind</li> <li>• Choice of luminaires, arms</li> <li>• Motion detection</li> <li>• Security cameras</li> </ul> </li> </ul>	<ul style="list-style-type: none"> <li>• Drill and drop – no cabling/trenching cost</li> <li>• No technical training required</li> <li>• 14 Smart Meters on phone to validate install</li> <li>• Built in communications for Smart Off-Grid</li> <li>• Proven, tested to meet lighting standards</li> </ul>	<ul style="list-style-type: none"> <li>• Smart Off-Grid means 7x24x365 remote monitoring, control and servicing</li> <li>• 80% reduction in maintenance costs</li> <li>• Proactive maintenance, service calls eliminated</li> <li>• Public website generated to promote green energy savings</li> <li>• Partnership approach – Illumient is there after the sale too!</li> </ul>

A technology to *manage, control and maintain* off-grid systems over the Internet

# What is Smart Off-Grid?

A technology to *manage, control and proactively service* off-grid systems over the Internet

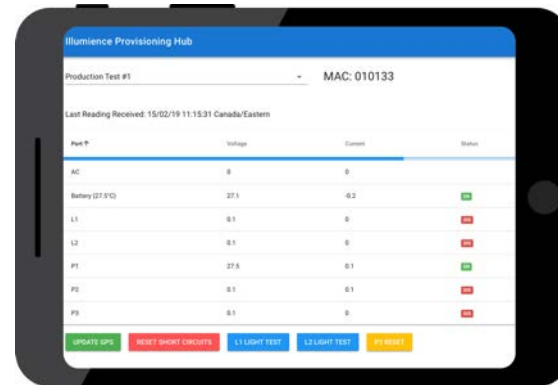
The tablet screen shows the 'Illumine Provisioning Hub' interface for 'Production Test #1' (MAC: 010133). It displays the last reading received on 15/02/19 at 11:15:31 Canada/Eastern. Below is a table of sensor readings and status indicators.

Part #	Voltage	Current	Status
AC	0	0	
Battery (27.5°C)	27.1	-0.2	OK
L1	0.1	0	ERR
L2	0.1	0	ERR
P1	27.6	0.1	OK
P2	0.1	0.1	ERR
P3	0.1	0	ERR

Control buttons at the bottom include: UPDATE GPS, RESET SHORT CIRCUITS, L1 LIGHT TEST, L2 LIGHT TEST, and P1 RESET.

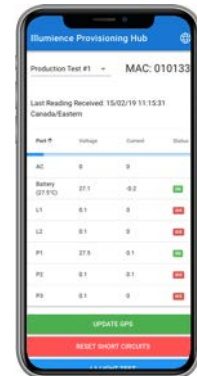

The smartphone screen shows the 'Illumine Provisioning Hub' interface for 'Production Test #1' (MAC: 010133). It displays the last reading received on 15/02/19 at 11:15:31 Canada/Eastern. Below is a table of sensor readings and status indicators.

Part #	Voltage	Current	Status
AC	0	0	
Battery (27.5°C)	27.1	-0.2	OK
L1	0.1	0	ERR
L2	0.1	0	ERR
P1	27.6	0.1	OK
P2	0.1	0.1	ERR
P3	0.1	0	ERR

Control buttons at the bottom include: UPDATE GPS, RESET SHORT CIRCUITS, L1 LIGHT TEST, L2 LIGHT TEST, and P1 RESET.

# Why Does Smart Off-Grid Matter?



Smartphone App to Verify Installation

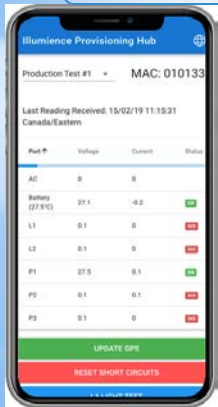

Drill & Drop, Plug & Play Solutions

SMART Controller Integrated Connectivity



Brighter Lights w/ Configurable Profiles

Remote Visibility & Control - Increases Reliability and Reduces Maintenance



Smaller Batteries Longer Life



**Most Cost Effective & Reliable System in the Market**

# Energy Analysis for Township of Head, Clara & Maria, ON

The analysis performed is based on average weather over the last 30 years

Scenario	Solar / Wind	Battery	Winter Energy (4 months)	Summer Energy (8 months)	Sample Light Wattage Profiles
A	1 x 300W	2 x 140Ah	300 Watt hours	780 Watt hours	Winter: 20 Watts all night, OR Custom profile designed for the customers needs Summer: 65 Watts all night
B	2 x 300W	2 x 140Ah	450 Watt hours	960 Watt hours	Winter: 30 Watts all night, OR Custom profile designed for the customers needs Summer: 80 Watts all night
C	2 x 300W	4 x 140Ah	675 Watt hours	1560 Watt hours	Winter: 45 Watts all night, OR Custom profile designed for the customers needs Summer: 130 Watts all night
D	Daisy + 1 x 300W	4 x 140Ah	600 Watt hours	1080 Watt hours	Winter: 40 Watts all night, OR Custom profile designed for the customers needs Summer: 90 Watts all night

## Includes Illumient Smart Off-Grid 6 Day Advanced Predictive Weather Forecasting



■ Extremely low energy Generation
 ■ Low energy generation
 ■ High energy generation

# ILLUMIENT Single Solar Off Grid System

## Configuration

- Black Metal pole – 20.5' pole including base enclosure at the bottom
- Enduralite Sigma Series ESLD-40 42Watt, 5,460 lumen light with pole mounting hardware on a 6' light arm
- Single 300W 60 cell solar panel and mounting hardware
- Dual 140Ah AGM, thick plate, long life, deep cycle battery lead acid batteries with 7 year warranty at 24VDC
- Clear Blue Technologies - Smart Off Grid Controller
- Prepackaged cabling harness kit for quick easy installation
- Includes 3 Years Energy as a Service (EaaS), which Include:
  - 3 years of Illumience Smart Off-Grid cloud based monitoring and control
  - 3 years of communications, cellular for single units and mesh/Ethernet or mesh/cellular for multi-pole projects

## Options

- Motion sensing - integrated with controller add \$300

**Pricing: \$ 5,727.43 each (based on quantity of 10 )**

**This does require a concrete base foundation**

- Site soil analysis and civil engineering is responsibility of the customer.
- Shipping, Installation and Taxes are extra
- Payment terms 50% deposit, 50% prior to shipping O.A.C.
- Designed to AASHTO 90mph
- Should customer require ESA site inspection, this fee is not included
- by Clear Blue and is the responsibility of the customer and/or contractor.
- Customer understands that full title and ownership of each component
- of the system transfers to the customer when shipped (F.O.B shipping and/or C.I.F., as applicable)

Based on Scenario A

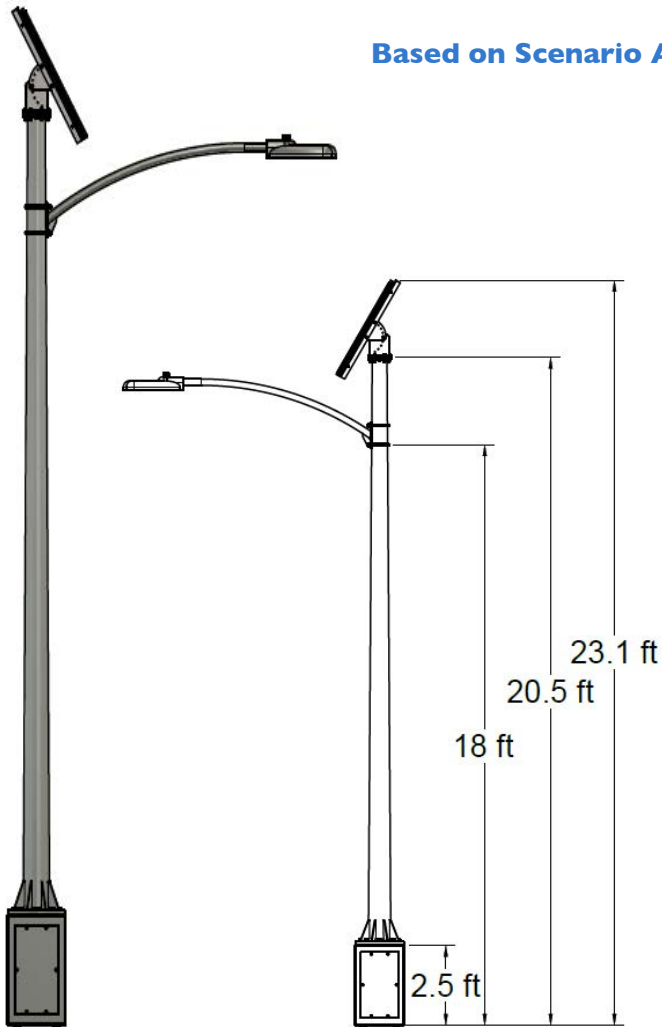

CBT-SSIL-MS20.5

**Motion Sensing  
Option**

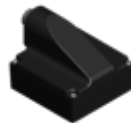

Metal  
Pole Series

**ILLUMIENT**

**Single Solar**



# Illumient Dual Solar Off Grid System

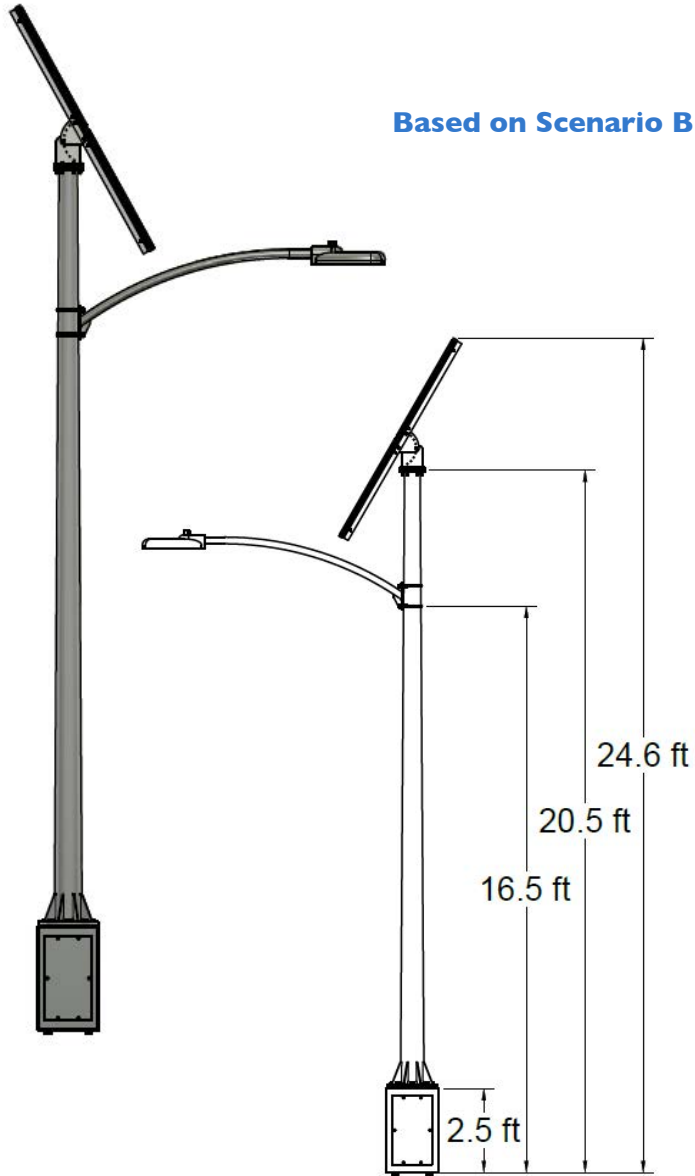

CBT-DSIL-MS20.5

**Motion Sensing  
Option**

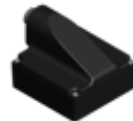

## Configuration

- Black Metal pole – 20.5' pole including base enclosure at the bottom
- Enduralite Sigma Series ESLD-40 42Watt, 5,460 lumen light with pole mounting hardware on a 6' light arm
- Dual 300W 60 cell solar panel and mounting hardware
- Dual 140Ah AGM, thick plate, long life, deep cycle battery lead acid batteries with 7 year warranty at 24VDC
- Clear Blue Technologies - Smart Off Grid Controller
- Prepackaged cabling harness kit for quick easy installation
- Includes 3 Years Energy as a Service (EaaS), which Include:
  - 3 years of Illumience Smart Off-Grid cloud based monitoring and control
  - 3 years of communications, cellular for single units and mesh/Ethernet or mesh/cellular for multi-pole projects

## Options

- Motion sensing - integrated with controller add \$ 300

**Pricing: \$ 6,039.68 each (based on quantity of 10 )**

**This does require a concrete base foundation**

- Site soil analysis and civil engineering is responsibility of the customer.
- Shipping, Installation and Taxes are extra
- Payment terms 50% deposit, 50% prior to shipping O.A.C.
- Designed to AASHTO 90mph
- Should customer require ESA site inspection, this fee is not included
- by Clear Blue and is the responsibility of the customer and/or contractor.
- Customer understands that full title and ownership of each component
- of the system transfers to the customer when shipped (F.O.B shipping and/or C.I.F., as applicable)

Metal  
Pole Series

**ILLUMIENT**

**Dual Solar**

# ILLUMIENT Dual Solar Off Grid System

## Configuration

- Black Metal pole – 22' pole including base enclosure at the bottom
- Enduralite Sigma Series ESLD-40 42Watt, 5,460 lumen light with pole mounting hardware on a 6' light arm
- Dual 300W 60 cell solar panel and mounting hardware
- Quad 140Ah AGM, thick plate, long life, deep cycle battery lead acid batteries with 7 year warranty at 24VDC
- Clear Blue Technologies - Smart Off Grid Controller
- Prepackaged cabling harness kit for quick easy installation
- 3 Years Energy as a Service (EaaS), which Includes:
  - 3 years of Illumience Smart Off-Grid cloud based monitoring & control
  - 3 years of communications, cellular for single units and mesh/Ethernet or mesh/cellular for multi-pole projects

## Options

- Motion sensing - integrated with controller add \$300

**Pricing: \$ 7,554.99 each (based on quantity of 10 )**

**This does require a concrete base foundation**

- Site soil analysis and civil engineering is responsibility of the customer.
- Shipping, Installation and Taxes are extra
- Payment terms 50% deposit, 50% prior to shipping O.A.C.
- Designed to AASHTO 90mph
- Should customer require ESA site inspection, this fee is not included
- by Clear Blue and is the responsibility of the customer and/or contractor.
- Customer understands that full title and ownership of each component
- of the system transfers to the customer when shipped (F.O.B shipping and/or C.I.F., as applicable)

Based on Scenario C

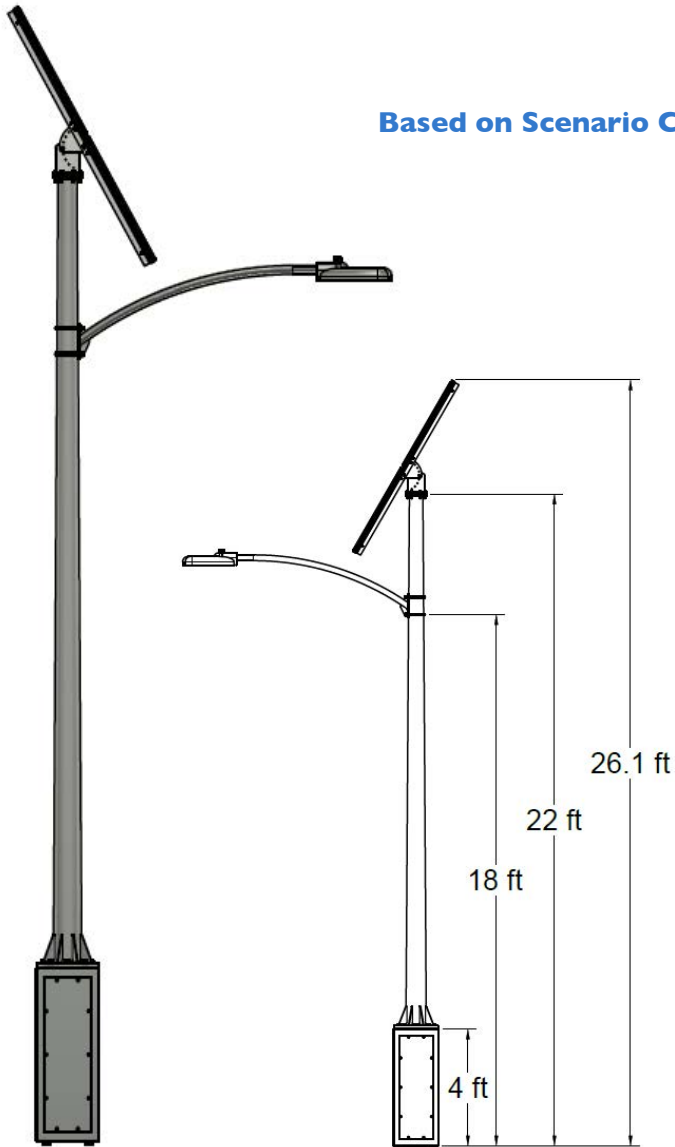

CBT-DSIL-MS22

**Motion Sensing  
Option**

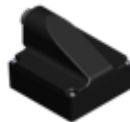

Metal  
Pole Series

**ILLUMIENT**

**Dual Solar**

# Illumient Hybrid Single Solar Off Grid System

Based on Scenario D

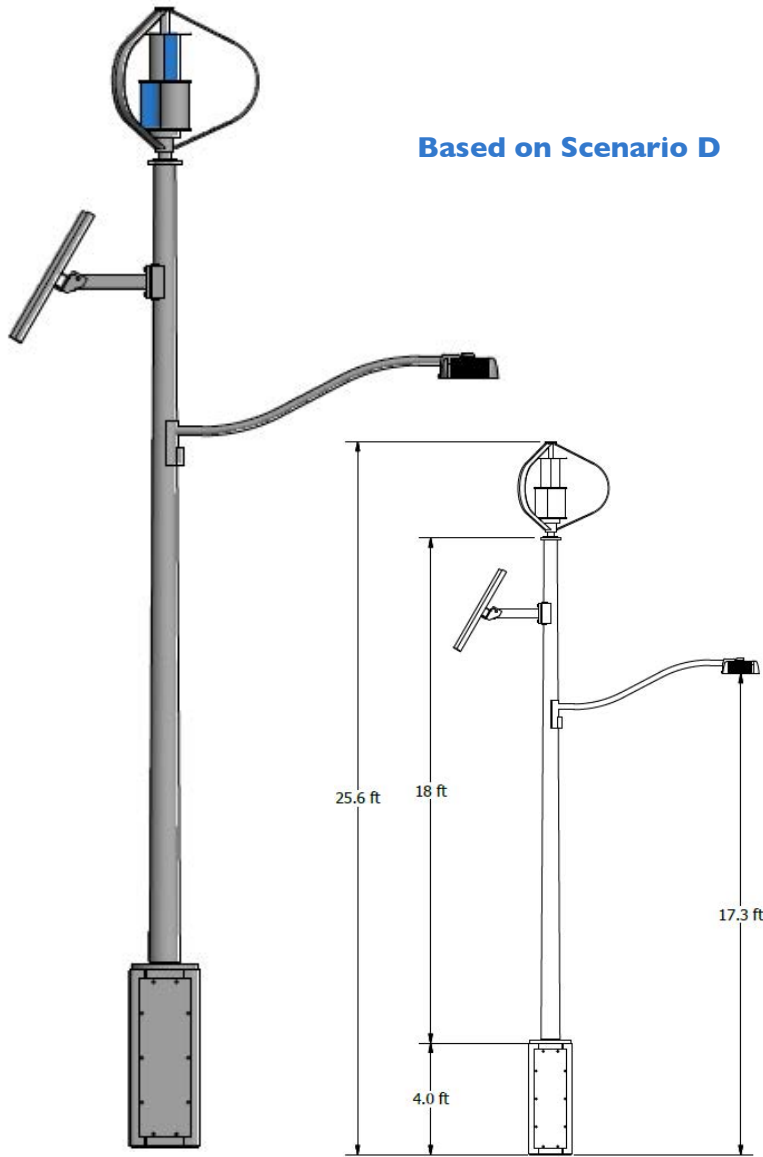

CBT-HSS IL-MS20.5

**Motion Sensing  
Option**

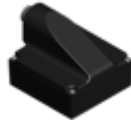

## Configuration

- Black Metal pole – 22' pole including base enclosure at the bottom
- Enduralite Sigma Series ESLD-40 42Watt, 5,460 lumen light with pole mounting hardware on a 6' light arm
- Single 300 W 60 cell solar panel and mounting hardware
- Quad 140 Ah AGM, thick plate, lead acid batteries at 24VDC
- 300W Wind turbine
- 3 Years Energy as a Service (EaaS), which Includes:
  - 3 years of Illumience Smart Off-Grid cloud based monitoring & control
  - 3 years of communications, cellular for single units and mesh/Ethernet or mesh/cellular for multi-pole projects

## Options

- Upgrade to long life, deep cycle battery with 7 year warranty
- Motion sensing - integrated with controller add \$300 ea

**Pricing: \$ 9,868.43 each (based on quantity of 10 )**  
**This does require a concrete base foundation**

- Site soil analysis and civil engineering is responsibility of the customer.
- Shipping, Installation and Taxes are extra
- Payment terms 50% deposit, 50% prior to shipping O.A.C.
- Designed to AASHTO 90mph
- Should customer require ESA site inspection, this fee is not included by Clear Blue and is the responsibility of the customer and/or contractor.
- Customer understands that full title and ownership of each component of the system transfers to the customer when shipped (F.O.B shipping and/or C.I.F., as applicable)

Metal  
Pole Series

# ILLUMIENT

## Hybrid Single Solar

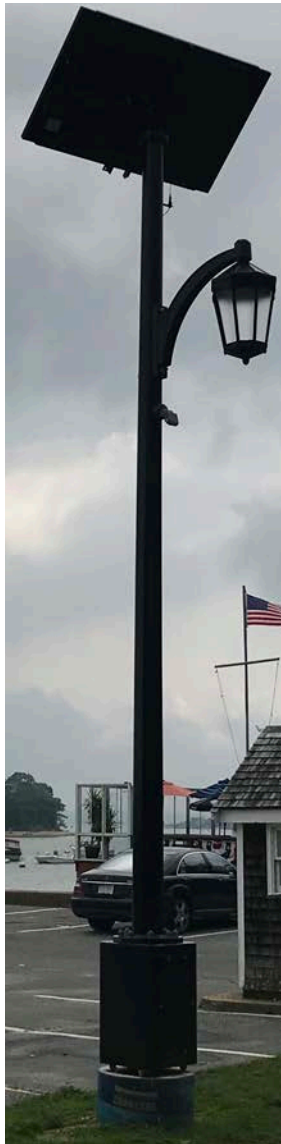

**ILLUMIENT**

Alternative Options

# Illumience Cloud Features

Promote your sustainability!

164463  
Kilowatt Hours Generated

110463  
Kilowatt Hours Consumed

168048  
Pounds of Carbon Offset

1811  
Trees Saved



**Validated install and provisioning via smartphone**



**Proactive, automated maintenance**



**7x24 system monitoring and status**



**Hourly, daily and monthly online reports**



**Set and change lighting and load profiles over the Internet**



**Security camera integration**



**Customizable alerts via email or SMS**



**Easy to use web interface**



**Predictive weather analysis**



**Multi-language support**

# Energy as a Service

- Expert power management from Clear Blue
- Little or no capital costs for energy storage and control
- Guaranteed battery life with our Smart Battery Management Plan eliminates risk
- No battery replacement costs
- Fixed, predictable annual maintenance cost

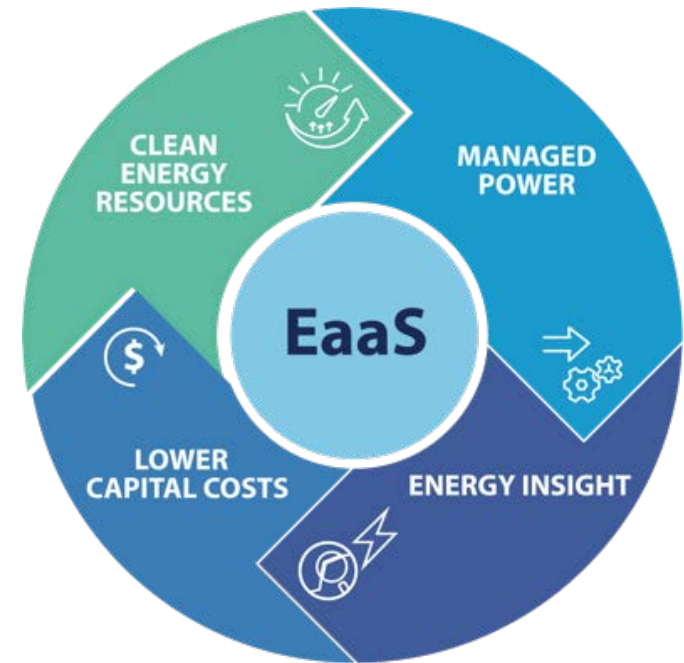

# Clear Blue Expert Service

- Based on Clear Blue’s Illumience cloud-based software, it includes 7x24 monitoring, proactive maintenance, diagnostic testing and fault determination.
- Clear Blue supports your team with expert service from our own control center, where all of your systems are also monitored and managed.



# Illumience: Real-time Monitoring & Control System

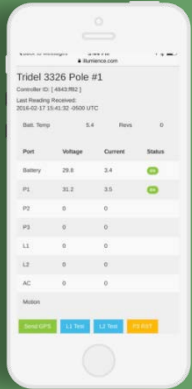

“ Smart Off-Grid Cloud Service, operated by Clear Blue ”

Part	Voltage	Current	Status
Battery	29.9	3.4	OK
P1	20.2	3.3	OK
P2	0	0	OK
P3	0	0	OK
L1	0	0	OK
L2	0	0	OK
AC	0	0	OK





# Illumience Remote Management and Control



Entire system is fully remote controllable and adjustable via Clear Blue's cloud-based Illumience software, including charging parameters, temperature compensation, remote solar panel troubleshooting and testing, emergency remote override, lighting profiles and more.

## Specification:

- Smart Off-Grid remote management and monitoring service must be delivered by the supplier on an ongoing basis with remote technical trouble shooting and support
- Remote management and control is delivered via a Cloud-based service
- All communications between units and Cloud shall be fully encrypted
- System shall have ability to provide forward looking weather forecast for the site with indications of whether the system will run out of energy
- User configurable alarms for any system failures and also WARNING alarms should an anticipated outage be expected in the near future
- Installation remote commissioning test must be able to do a light test, solar panel test, battery test, short circuit tests, etc.
- Full ability to remotely control each individual system AND also all systems together as a group
- Ability to detect shading of the system during different times of the year and also be able to adjust individual systems based upon shading.
- Ability to adjust lights remotely to ensure system up time even during extra long 'no sun' and low sun periods, up to 5-10 days.

# ILLUMIENT

## Off Grid Remote Management

## Motion Detection Option

- Lights turn off when no one is around, turn on when someone approaches
- Reduces battery draw when lights are not needed
- Motion sensors help with liability issues and safety
- Data captured provides valuable information on light usage, traffic patterns and more



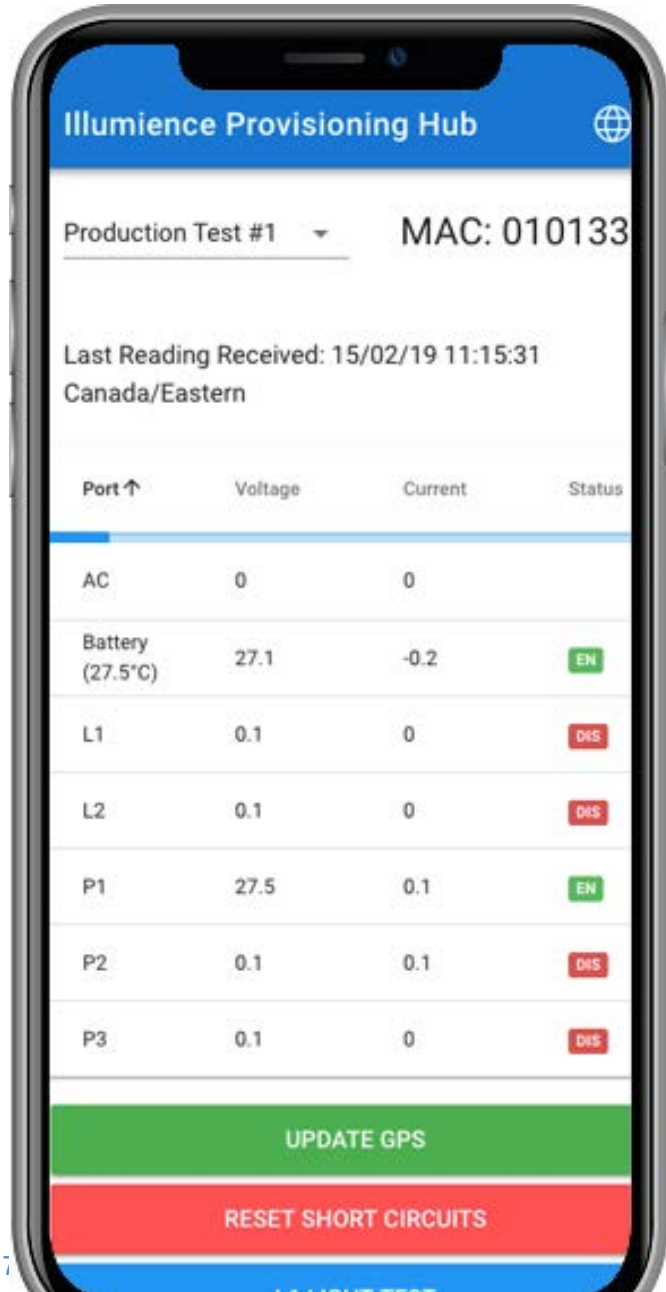

## Validated Installations

Smartphone app ensures proper install before your installer leaves the pole!

14 simultaneous meter readings

# Optional Internet of Things: Applications

- Security/CCTV cameras, other security devices
- Pedestrian traffic counters
- Smart traffic management, congestion relief
- Air quality/pollution and chemical monitoring
- Smart parking systems
- WiFi hotspots
- Feed for real time consumer apps (parking, traffic, safety, more)
- Sustainable energy/carbon credits
- Energy reduction and optimization

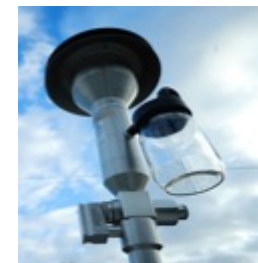

# Where in the World Is Clear Blue?

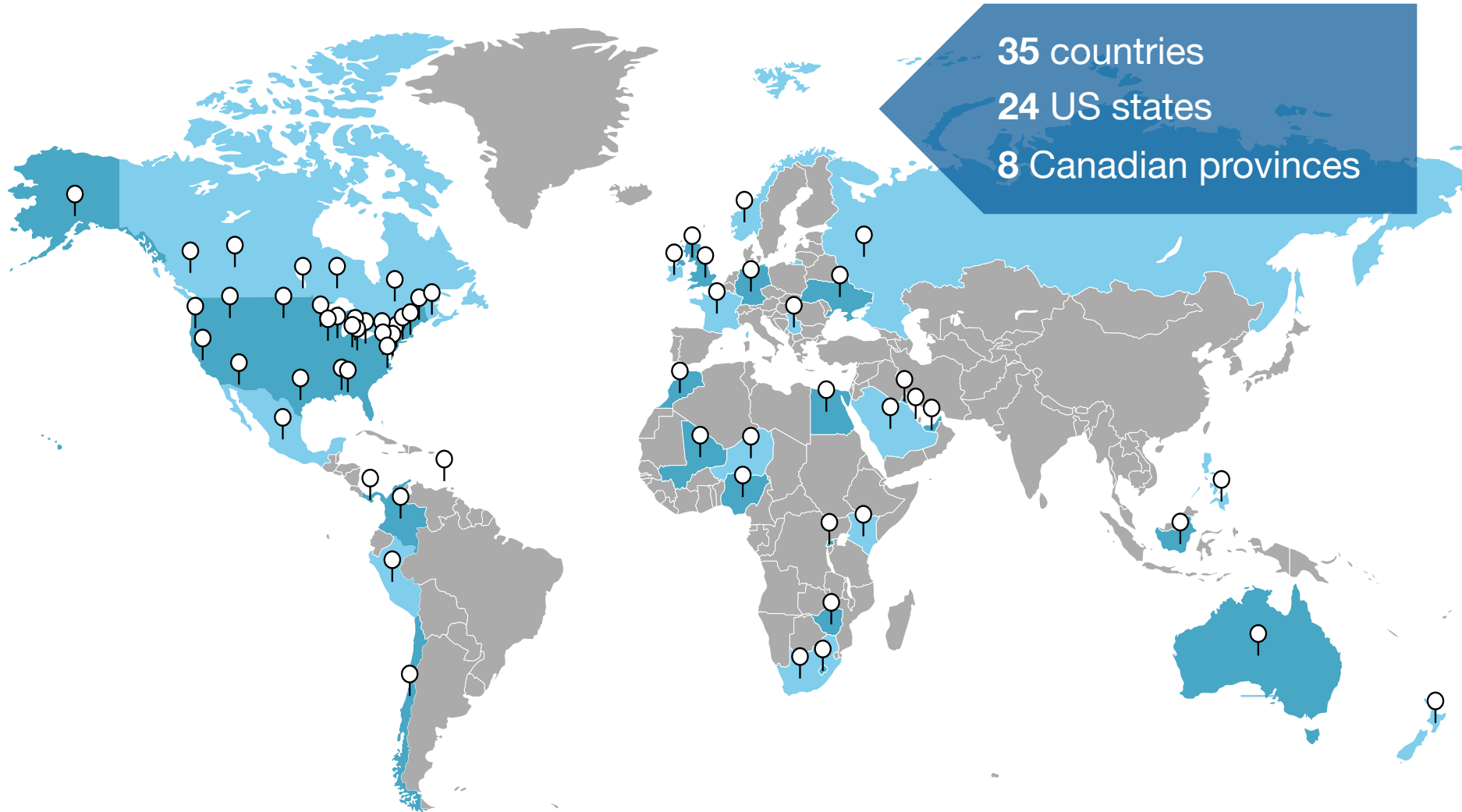

United Townships of Head, Clara & Maria Council

Request for Decision

Type of Decision									
Meeting Date	Thursday, September 17, 2020				Report Date	Wednesday, September 11, 2020			
Decision Required	X	Yes		No	Priority	X	High		Low
Direction	X	Information Only			Type of Meeting	X	Open		Closed
<b>Report #20/09/17/1101 – Haines Severance</b>									

**Subject:** Proposed severance of property on Colton Creek Rd

**Recommendation:** That Council review attached severance documentation and provide comments for “Consent Planning Report”

**Background/Executive Summary:**

CBO has reviewed the proposal and sees no issues with building a single family dwelling and septic system because of the size and soil composition of the lot.

See attached documents for other information.

**Financial Considerations/Budget Impact:**

None at this time.

**Enclosures:**

- Letter and questionnaire from County of Renfrew
- Notice of an Application for Consent
- Consent Planning Report (B19/20A)
- Consent Planning Report (B20/20A)
- Ministry of Transportation Response

Approved and Recommended by the Clerk

Charlotte Toope,  
Clerk/Treasurer

Department of Development &  
Property



9 INTERNATIONAL DRIVE  
PEMBROKE, ON, CANADA  
K8A 6W5  
613-735-3204  
FAX: 613-735-2081  
www.countyofrenfrew.on.ca

July 7, 2020

CAO/Clerk Treasurer  
Township of Head Clara Maria  
15 Township Hall Rd.  
Stonecliffe, ON K0J 2K0

Dear Sir/Madame:

**Owners:** Theresa Marie Haines & Edwin Robert Haines

**Location of Land:** Part of Lot 1, Concession A  
Geographic Township of Head  
Township of Head, Clara, Maria  
**B19/20(1)** (64.7m x 340m – 2.0 ha. (4.94 ac.)  
**B20/20(2)** (80m x 280m – 2.0 ha. (4.94 ac.)

The above referenced Applications For Consent has been received for consideration by the County of Renfrew. A copy of the applications is attached. In accordance with Sections 53(11) and 53(5)(a) of the Planning Act, your written comments are required.

A Notice of an Applications for Consent is attached that includes a key map showing the location of the proposed consent.

Yours truly,

*Alana Zadow*

Alana Zadow, ACST  
Secretary-Treasurer  
Land Division Committee  
azadow@countyofrenfrew.on.ca  
/az  
Enclosures

MUNICIPAL REPORT

TO

RENFREW COUNTY PLANNING DIVISION AND LAND DIVISION COMMITTEE

Property Assessment Roll No 47-98-000-010-094-00  
Municipality: Township of Head  
Township of Head, Clara & Maria

Consent Application File No. B /20( )  
Owners: Theresa Marie Haines &  
Edwin Robert Haines

Please Note: For those questions requiring “yes”, “no” or don’t know” answers, please circle the appropriate response.

**1. Official Plan and/or Zoning By-law (if applicable)**

(a) Please specify the following:

	<u>Official Plan Designation</u>	<u>Zoning By-law Zone</u>
Severed Lot:	_____	_____
Retained Lot:	_____	_____

(b) Does the proposed division of land conform to the Official Plan?

Yes    No

Comments: \_\_\_\_\_

(c) Do the severed and retained lots meet all the requirements of the Zoning By-law?

Yes    No

Comments: \_\_\_\_\_

**2. Services**

(a) Please mark which of the following services are available:

	<u>Municipal Water</u>	<u>Sanitary Sewers</u>	<u>Garbage Collection</u>
Severed Lot:	___	___	___
Retained Lot:	___	___	___



(b) Please mark what type of road the subject lots front on:

	Open Municipal Road (Maintained)	County Road	Provincial Highway	Other (e.g., unopened public road)
	Year Round	Seasonal		
Severed Lot:	_____	_____	_____	_____
Retained Lot:	_____	_____	_____	_____

(c) If the subject lands front on a municipal road, please indicate if the municipality is prepared to provide an entrance off the municipal road.

	Will provide entrance permit	Will not provide entrance permit	Approved entrance already exists
Severed Lot:	_____	_____	_____
Retained Lot:	_____	_____	_____

(d) If access is by a municipal public road is road widening required?

Yes No

(e) If access is by a private road, is Council satisfied that the condition of the road is appropriate for access by emergency vehicles?

Yes No

(f) Would approval of this severance create any civic addressing conflicts?

Yes No Don't Know

Comments: \_\_\_\_\_

(g) Does a school bus service the area at the present time?

Yes No

(h) If not, how far is the severed lot from the closest serviced point? \_\_\_\_\_

(i) In the view of the Municipality, would the proposed use of land place an undue burden on the provision of municipal services such as road maintenance and garbage collection?

Yes No Don't Know

### 3. Land Use and Site Suitability

- (a) Does the Municipality consider the size and shape of the lands affected by this application for consent to be appropriate for the intended use of the property?

Yes No Don't Know

Comments: \_\_\_\_\_

- (b) Does the Municipality consider the proposed use of the severed and retained lands to be compatible with the surrounding use of land?

Yes No Don't Know

Comments: \_\_\_\_\_

- (c) Is the slope of the land to be severed and of the land to be retained suitable to permit the proper siting of any buildings proposed?

Yes No Don't Know

Comments: \_\_\_\_\_

- (d) Are soil and drainage conditions of the area suitable to permit the proper siting of any buildings or structures for the severed or retained lands?

Yes No Don't Know

Comments: \_\_\_\_\_

- (e) Has the Municipality reviewed reports from any of the following?

i)	Zoning Administrator	Yes	No
ii)	Roads Superintendent	Yes	No
iii)	Fire Chief	Yes	No
iv)	Chief Building Official	Yes	No
v)	Septic Inspector	Yes	No
vi)	Engineer	Yes	No
vii)	Lawyer	Yes	No
viii)	Other (specify) _____	Yes	No

- (f) Is a plan of subdivision more appropriate for the proper and orderly development of the land affected by this application for consent?

Yes No Don't Know

**4. Municipality Recommendations:**

(a) Does the Municipality recommend consent be granted?                      Yes      No

Comments: \_\_\_\_\_  
\_\_\_\_\_  
\_\_\_\_\_  
\_\_\_\_\_

(b) If consent is granted, what conditions would the Municipality wish to see applied?  
(i.e., road widening, lot levy, Parkland dedication etc)

\_\_\_\_\_  
\_\_\_\_\_  
\_\_\_\_\_  
\_\_\_\_\_  
\_\_\_\_\_

(c) Additional Comments:

Any other comments, information or technical reports that you wish to bring to the attention of the Land Division Committee can be added below or attached to this form.

\_\_\_\_\_  
\_\_\_\_\_  
\_\_\_\_\_

Date: \_\_\_\_\_

Signed: \_\_\_\_\_  
(Signature of Municipal Official)



**NOTICE OF AN APPLICATION FOR CONSENT**  
**(Land Severance)**  
**Section 53(5)(a) of the Planning Act and O. Reg. 197/96**

**TAKE NOTICE** that the County of Renfrew has received an application for consent under Section 53(1) of the Planning Act for the following lands:

Application Number:	<b>B19/20(1) &amp; B20/20(2)</b>
Location of Subject Lands:	<b>Part Lot 11, Concession A, Head</b>
Municipality:	<b>Township of Head, Clara &amp; Maria</b>
Name of Applicant:	<b>Theresa Marie Haines &amp; Edward Robert Haines</b>

**PURPOSE AND EFFECT:**

The purpose and effect of the applications is to sever two residential lots. B19/20(1) is proposed to be 2.43 ha. (6 acres) in size and B20/20(2) is proposed to be 2 ha. (4.94 acres) in size. A key map showing the approximate location of the proposed consent is on the reverse of this notice.

**OTHER RELATED INFORMATION:**

Pursuant to the Planning Act, this Notice of Application for Consent shall be given *to every landowner within 60 metres of the subject land and to prescribed persons and public bodies.*

**TO MAKE SUBMISSIONS:**

If you wish to make a written submission, please ensure that your letter/email contains your name, address, telephone number/email address and planning concerns/objections, and that it is addressed to the Secretary-Treasurer of the Land Division Committee of the County of Renfrew, 9 International Drive, Pembroke, Ontario K8A 6W5.

**NOTE:** *One of the purposes of the Planning Act is to provide for planning processes that are open, accessible, timely and efficient. Accordingly, all written submissions, documents, correspondence, e-mails or other communications (including your name and address) form part of the public record and will be disclosed/made available by the County to such persons as the County sees fit, including anyone requesting such information. Accordingly, in providing such information, you shall be deemed to have consented to its use and disclosure as part of the planning process.*

*If a person or public body that files an appeal of a decision of the Land Division Committee of the County of Renfrew in respect of the proposed consent does not make written submissions to the Land Division Committee of the County of Renfrew before it gives or refuses to give a provisional consent, the Local Planning Appeal Tribunal (LPAT) may dismiss the appeal.*

**NOTICE OF DECISION:**

If you wish to be notified of the decision of the Land Division Committee of the County of Renfrew in respect of the proposed consent, you must make a written request to the Secretary-Treasurer of the Land Division Committee of the County of Renfrew. Such request should contain your name, address, telephone number/email address.

Please refer to the application number in all correspondence and communications.

**ADDITIONAL INFORMATION:**

Additional information concerning this consent application is available for public inspection during office hours at the offices of the Development and Property Department of the County of Renfrew, 9 International Drive, Pembroke, Ontario or you may contact the Secretary-Treasurer of Land Division by telephone at (613) 735-3204 or toll-free 1-800-273-0183. Office Hours are Monday to Friday 8:00 a.m. to 4:00 p.m.

Dated at the County of Renfrew this 23<sup>rd</sup> day of April, 2020.

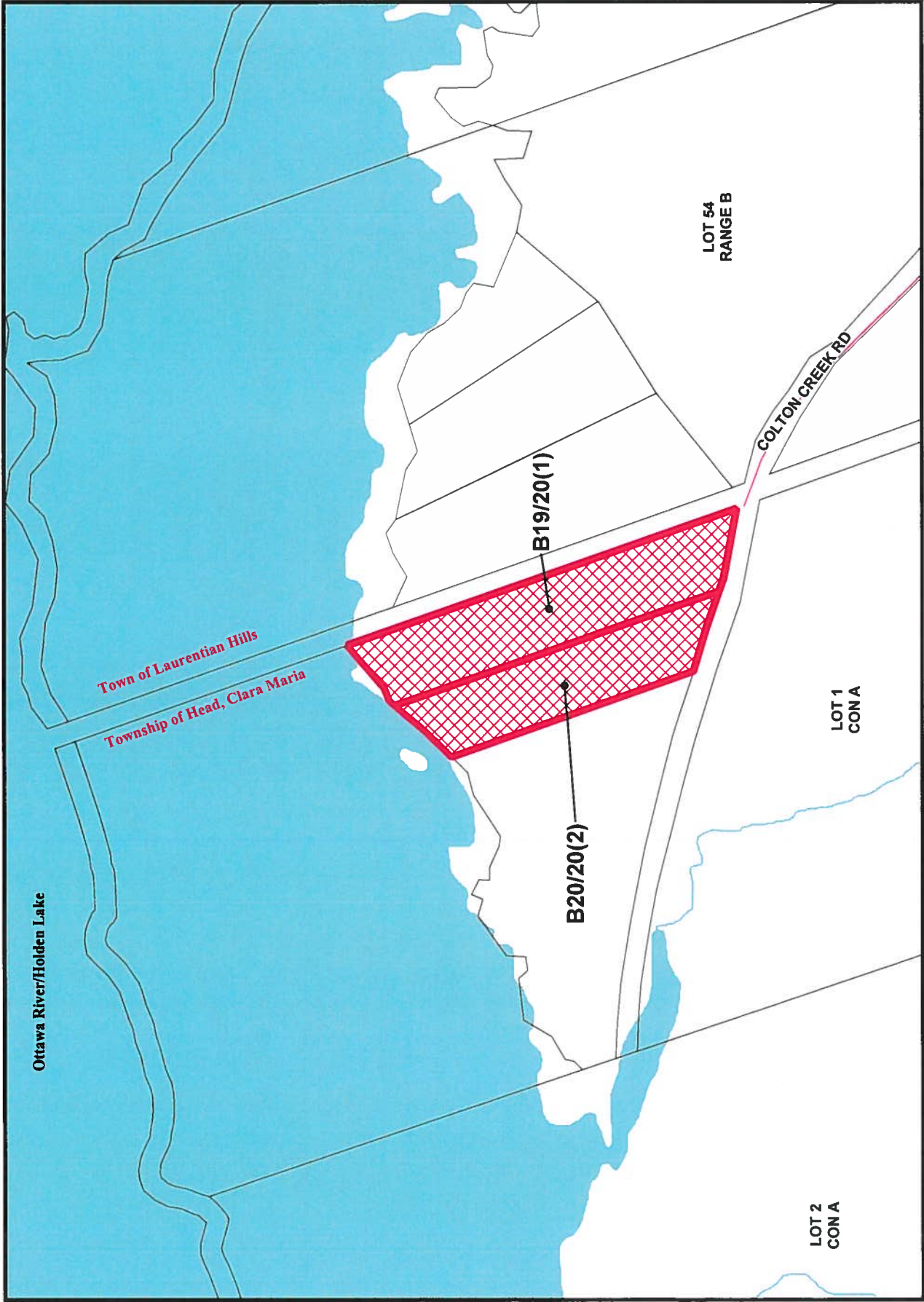

**KEY MAP**  
 Township of HEAD, CLARA, MARIA  
 (geographic Township of Head)

1 centimeter = 50 meters



**Development & Property  
Department  
CONSENT PLANNING REPORT  
TO THE COUNCIL OF THE  
TOWNSHIP OF HEAD, CLARA & MARIA**

**PART A - BACKGROUND**

1. FILE NO.: **B19/20(1)**
2. APPLICANTS: Theresa Marie & Edwin Robert Haines
3. MUNICIPALITY: Head, Clara & Maria  
(geographic Township of Head)
4. LOT: Part Lot 1 CON.: A STREET: 260 Colton Creek Road
5. PURPOSE: Creation of a new lot

	<u>Severed</u>	<u>Retained</u>	<u>Lot Being Added To</u>
6. <u>OFFICIAL PLAN OF THE COUNTY OF RENFREW</u> Official Plan Designation(s):	Rural	Rural	n/a
7. <u>ZONING BY-LAW OF THE TWP OF HEAD, CLARA &amp; MARIA</u> (#2004-12) Zone (s):	General Provisions	General Provisions	n/a

8. SITE PERFORMANCE STANDARDS:

	<u>Proposed Lot Area</u>	<u>Zoning By-law Requirement</u>	<u>Proposed Lot Frontage</u>	<u>Zoning By-law Requirement</u>
Severed	2.0 ha	<b>2025 m<sup>2</sup></b>	64.7 m	<b>30 m</b>
Total, if Lot Addition	- m <sup>2</sup>	- m <sup>2</sup>	- m	- m
Retained	9.23 ha	<b>2025 m<sup>2</sup></b>	425.3 m	<b>30 m</b>

\* Note: There are two concurrent severance applications. If both new lots are granted, the final retained lands would be 7.23 hectares with 345.3 metres of road frontage.

9. SEVERANCE HISTORY  
Number of new lots from original holding (1971)      No previous severances

10. BUILT-UP AREA      Yes       No

**PART B – COMMENTS**

**1. CONFORMITY WITH OFFICIAL PLAN**

- (a) The proposal conforms with the Official Plan, based on the information available to this Department.
  
- (b) The proposal will conform with the Official Plan if/when, (Sec. Nos.)   
Under 14.3(19), the severed lot meets the criteria for private road development.
  
- (c) The proposal does not meet the intent of the Official Plan because,

**2. CONFORMITY WITH ZONING BY-LAW**

- (a) The proposal appears to meet the requirements of the Zoning By-law.
  
- (b) The severed/retained portion/overall proposal would contravene the By-law because,

**3. PROVINCIAL POLICY STATEMENT and MUNICIPAL PLAN REVIEW DATA**

No Concerns  Concerns

Explanation of Concerns:

#### **4. GENERAL PLANNING COMMENTS**

Two concurrent consent applications have been submitted to create new waterfront lots on the Ottawa River. Both lots are 2 hectares in area and have over 60 metres of water frontage. The lots are to be accessed by Colton Creek Road which is an existing private road. If both new lots are granted, the final retained lands would be 7.23 hectares in area with 345.3 metres of road frontage on Colton Creek Road and would have 335.54 metres of water frontage. There is an existing seasonal camp on both of the severed parcels. The retained lands have an existing cottage and garage.

Our information shows that the total lot area of the subject lands is 2.3 hectares (5.68 acres) whereas the based on the two applications, the lot area is shown as 11.23 hectares (27.7 acres). Confirmation of the size of the severed and retained lands is required.

The severed and retained lands are proposed to be accessed a private road section of Colton Creek Road. Colton Creek Road is an open and maintained Township road from the edge of the subject lands. Section 14.3(19) of the County of Renfrew Official Plan, permits a private road to be used for access to waterfront lots provided that the road meets certain criteria including:

- That the right-of-way is legally obtained and secured and connects to an open year round public road;
- The road standards, the responsibility of the lot owner for maintenance should be set out to the local Council's satisfaction in a development agreement between the local municipality and the landowners; and
- That the private road must meet municipal standards for access of emergency vehicles.

The subject lands are in close proximity to the Ministry of Transportation (MTO). The application will be circulated to MTO, and favourable comments are required.

#### **5. RECOMMENDATIONS**

- (a) Planning concerns have NOT been identified in this report. Therefore, consent may be appropriate if supported by Council and the agencies.
- (b) There are some planning concerns which Council should deal with as follows, before deciding whether to support the consent.



- (c) The proposal may be acceptable when the following matters are addressed and resolved:
- The Township confirms the suitability of the access road and the need for a private road agreement.
  - Favourable comments from the Ministry of Transportation (MTO).
  - Confirmation of the size of the severed and retained lots is required.
- (d) Conditions to the giving of consent should be considered for the following:
- Registered Plan of Survey
  - Zoning By-law Amendment:
  - Minor Variance:
  - Private Road Agreement: If required by the Township to define the level or road service and identifies the responsibility of the users for maintenance.
  - Development Agreement:
  - Site Plan Control Agreement:
  - Notice on Title:
  - Shoreline Road Allowance Closure / Acquisition:
  - Other:
- (e) There are serious planning concerns, refusal is recommended.
- (f) Other Recommendations:

---

Date: June 19, 2020  
Planner: Bruce Howarth, MCIP, RPP  
Senior Planner



**Development & Property  
Department  
CONSENT PLANNING REPORT  
TO THE COUNCIL OF THE  
TOWNSHIP OF HEAD, CLARA & MARIA**

**PART A - BACKGROUND**

1. FILE NO.: **B20/20(2)**
2. APPLICANTS: Theresa Marie & Edwin Robert Haines
3. MUNICIPALITY: Head, Clara & Maria  
(geographic Township of Head)
4. LOT: Part Lot 1 CON.: A STREET: 260 Colton Creek Road
5. PURPOSE: Creation of a new lot

	<u>Severed</u>	<u>Retained</u>	<u>Lot Being Added To</u>
6. <u>OFFICIAL PLAN OF THE COUNTY OF RENFREW</u> Official Plan Designation(s):	Rural	Rural	n/a
7. <u>ZONING BY-LAW OF THE TWP OF HEAD, CLARA &amp; MARIA</u> (#2004-12) Zone (s):	General Provisions	General Provisions	n/a

8. SITE PERFORMANCE STANDARDS:

	<u>Proposed Lot Area</u>	<u>Zoning By-law Requirement</u>	<u>Proposed Lot Frontage</u>	<u>Zoning By-law Requirement</u>
Severed	2.0 ha	<b>2025 m<sup>2</sup></b>	80 m	<b>30 m</b>
Total, if Lot Addition	- m <sup>2</sup>	- m <sup>2</sup>	- m	- m
Retained	9.23 ha	<b>2025 m<sup>2</sup></b>	410 m	<b>30 m</b>

\* Note: There are two concurrent severance applications. If both new lots are granted, the final retained lands would be 7.23 hectares with 345.3 metres of road frontage.

9. SEVERANCE HISTORY  
Number of new lots from original holding (1971)      No previous severances

10. BUILT-UP AREA      Yes       No

**PART B – COMMENTS**

**1. CONFORMITY WITH OFFICIAL PLAN**

- (a) The proposal conforms with the Official Plan, based on the information available to this Department.
  
- (b) The proposal will conform with the Official Plan if/when, (Sec. Nos.)   
Under 14.3(19), the severed lot meets the criteria for private road development.
  
- (c) The proposal does not meet the intent of the Official Plan because,

**2. CONFORMITY WITH ZONING BY-LAW**

- (a) The proposal appears to meet the requirements of the Zoning By-law.
  
- (b) The severed/retained portion/overall proposal would contravene the By-law because,

**3. PROVINCIAL POLICY STATEMENT and MUNICIPAL PLAN REVIEW DATA**

No Concerns  Concerns

Explanation of Concerns:

#### **4. GENERAL PLANNING COMMENTS**

Two concurrent consent applications have been submitted to create new waterfront lots on the Ottawa River. Both lots are 2 hectares in area and have over 60 metres of road and water frontage. The lots are to be accessed by Colton Creek Road which is an existing private road. If both new lots are granted, the final retained lands would be 7.23 hectares in area with 345.3 metres of road frontage on Colton Creek Road and would have 335.54 metres of water frontage. There is an existing seasonal camp on both of the severed parcels. The retained lands have an existing cottage and garage.

Our information shows that the total lot area of the subject lands is 2.3 hectares (5.68 acres) whereas the based on the two applications, the lot area is shown as 11.23 hectares (27.7 acres). Confirmation of the size of the severed and retained lands is required.

The severed and retained lands are proposed to be accessed a private road section of Colton Creek Road. Colton Creek Road is an open and maintained Township road from the edge of the subject lands. Section 14.3(19) of the County of Renfrew Official Plan, permits a private road to be used for access to waterfront lots provided that the road meets certain criteria including:

- That the right-of-way is legally obtained and secured and connects to an open year round public road;
- The road standards, the responsibility of the lot owner for maintenance should be set out to the local Council's satisfaction in a development agreement between the local municipality and the landowners; and
- That the private road must meet municipal standards for access of emergency vehicles.

The subject lands are in close proximity to the Ministry of Transportation (MTO). The application will be circulated to MTO, and favourable comments are required.

#### **5. RECOMMENDATIONS**

- (a) Planning concerns have NOT been identified in this report. Therefore, consent may be appropriate if supported by Council and the agencies.
- (b) There are some planning concerns which Council should deal with as follows, before deciding whether to support the consent.

- (c) The proposal may be acceptable when the following matters are addressed and resolved:
- The Township confirms the suitability of the access road and the need for a private road agreement.
  - Favourable comments from the Ministry of Transportation (MTO).
  - Confirmation of the size of the severed and retained lots is required.
- (d) Conditions to the giving of consent should be considered for the following:
- Registered Plan of Survey
  - Zoning By-law Amendment:
  - Minor Variance:
  - Private Road Agreement: If required by the Township to define the level or road service and identifies the responsibility of the users for maintenance.
  - Development Agreement:
  - Site Plan Control Agreement:
  - Notice on Title:
  - Shoreline Road Allowance Closure / Acquisition:
  - Other:
- (e) There are serious planning concerns, refusal is recommended.
- (f) Other Recommendations:

---

Date: June 19, 2020  
Planner: Bruce Howarth, MCIP, RPP  
Senior Planner

# County OP

B20 (2)

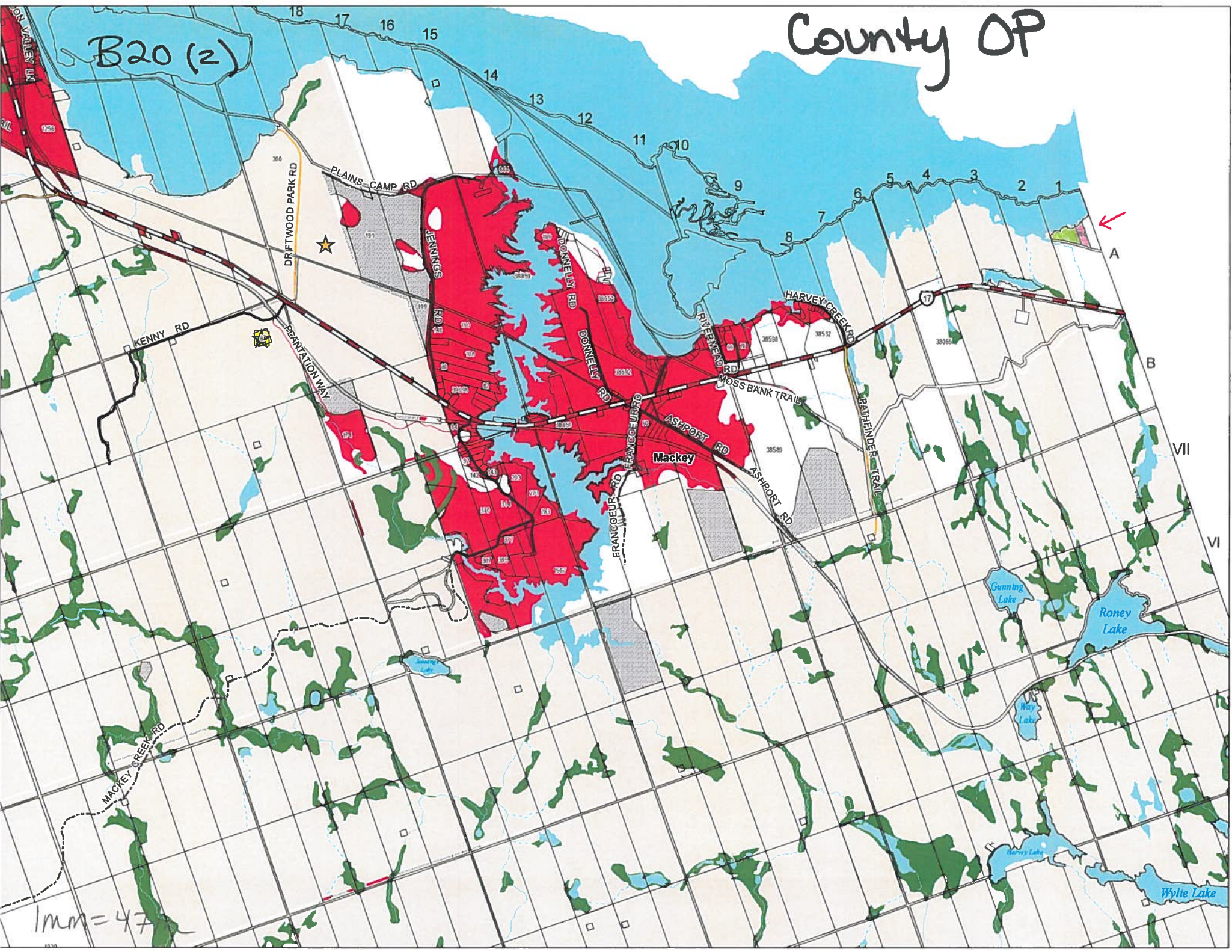

1mm = 47m

**Ministry of Transportation**

Corridor Management Section  
1355 John Counter Boulevard  
Postal Bag 4000  
Kingston, Ontario K7L 5A3  
Tel.: 613 545-4834  
Fax: 613-540-5106  
Stephen.Kapusta@ontario.ca

**Ministère des Transports**

Section de gestion des couloirs routiers  
1355, boulevard John Counter  
CP/Service de sacs 4000  
Kingston (Ontario) K7L 5A3  
Tél.: 613 544-2220  
Télééc. 613 540-5106



Alana Zadow, ACST  
Secretary-Treasurer, Land Division  
County of Renfrew  
9 International Drive  
Pembroke, ON K8A 6W5  
*Sent via email*

September 10, 2020

**RE: Haines Severances B19-20, B20-20  
Lot 1, Concession A Geographic Township of Head  
Ministry of Transportation comments  
Highway 17**

---

The ministry has reviewed both of the above noted severance applications and there are some issues that will need to be addressed prior to us being able to accept the proposed creation of these two lots.

The property in question fronts on a former stretch of Highway 17 that was flooded, and later closed by Order in Council. The lands that make up this former right of way are still owned by the Ministry, but are no longer designated highway based on the information both in the submission to us and in our mapping. While it is clear that the owners have an easement over this former right of way to access this property, in my opinion, this easement doesn't entitle the creation of further properties to have access over this former right of way. Likewise, it is not clear whether lots can be created via the Planning Act, as one of the proposed lots are technically land locked with the other adjacent to an unopened road allowance forming the division between the Geographic Township of Head and the Geographic Township of Rolph.

In order to proceed further, I will need to speak to our Property Division and to Geomatics to determine if this former right of way is going to be given to the Township or if it has already been transferred and isn't reflected in our mapping correctly. It will therefore be helpful to understand who is maintaining this former right of way, or if anyone is maintaining this former right of way. Likewise, a legal opinion should be sought by the applicants as to the ability of the land division committee to create these parcels. This opinion will need to be reviewed by the ministry and our legal division.

If these matters can be addressed satisfactorily, the ministry can endorse the application.

The proponent should be made aware that the subject property is within the Ministry's permit control area as defined by the Public Transportation and Highway Improvement Act R.S.O. 1990. Therefore, Ministry approvals and permits are required prior to the construction and/or demolition of any building and/or structures and/or alteration of the grade of any property within the permit control area and prior to the issuance of any municipal building permits or approvals as per section 8. (2) and section 8. (3) of the Building Code Act.

The above comments are valid for one year after the date shown in this letter. Changes to the submitted plans require updated comments.



Please feel free to contact me if you have any questions.

Sincerely,

Stephen Kapusta MCIP, RPP  
Senior Project Manager

cc Kingston Area Office  
Corridor Management

*United Townships of Head, Clara & Maria Council*

**Request for Decision**

Type of Decision									
Meeting Date	Thursday, September 17, 2020				Report Date	Wednesday, September 11, 2020			
Decision Required	X	Yes		No	Priority	X	High		Low
Direction	X	Information Only			Type of Meeting	X	Open		Closed
<b>Report #20/09/17/1102 – IT Contract</b>									

**Subject:** IT contract for HCM Municipal Office

**Recommendation:** That Council review the attached proposed Tech Care Plan and quote. Clerk-Treasurer recommends continuing to use JMT on an as needed basis, without a contract.

**Background/Executive Summary:**

At the August 22<sup>nd</sup>, 2020 meeting, the Clerk-Treasurer was directed to investigate the cost of an IT contract with JMT Solutions, the company that completed our network upgrades.

Considering the current requirements of the office, having this company on stand-by and using on an as needed basis is felt to be an adequate option for staff. JMT has provided us with this option.

**Financial Considerations/Budget Impact:**

Dependent upon Council decision. Costs outlined in attached quote.

**Enclosures:**

JMT Solutions – Total Tech Care

Approved and Recommended by the Clerk
Charlotte Toope, Clerk/Treasurer

# JMT Solutions

## Total Tech Care

### Silver Plan

Prepared for: Township of Head, Clara, Maria

Aug 24<sup>th</sup>, 2020

## Contents

Introduction.....	3
Total Tech Care Plans .....	4
Monitoring.....	5
Monitoring and proactive response for workstations .....	5
Monitoring and proactive response for servers.....	5
Monitoring and proactive response for network equipment .....	5
Break\Fix support calls .....	5
Hourly & Project rate.....	5
Support Services.....	5
Onsite Support M-F 8am-5pm.....	5
Workstation Add-Move-Change.....	5
After Hours Support - 5:01pm-7:59am .....	5
Workstation Patching & AV Patching .....	5
Remote Workstation Maintenance .....	6
Server Patching & AV Patching.....	6
Onsite Server Maintenance.....	6
Remote Server Maintenance.....	6
Network Optimization .....	6
Security Maintenance & Best Practices.....	6
Travel.....	6
TERM .....	7
COST AND PAYMENT SCHEDULE .....	7

## Introduction

Thank you for the opportunity to quote a Total Tech Care (TTC) plan, Silver Package. *The following pages describe the features included in our plan offerings with all features included in our top level Platinum plan.*

A JMT Solutions TTC Plan is designed to provide enhanced IT services for your business by providing proactive services and support instead of the traditional break-fix model. With proactive support IT issues are identified and rectified before impacting staff and operations.

Included with all proactive monitoring plans are the deployment of Windows Updates and Antivirus Updates to keep your systems secure and running smoothly. With our Gold plan, in addition to proactive monitoring and updates is remote system maintenance and support.

Our all-encompassing Platinum plan provides full onsite and remote support services to keep your computer systems, network, and server infrastructure operating at optimal performance. Full Antivirus protection is also included. With a predictable monthly rate, all IT support services listed under your contract are covered with no additional costs.

## Total Tech Care Plans

 Your Trusted Technology Partner	Total Tech Care Plans					
	Break \ Fix	Block Hours	Monitoring Bronze	Silver	Gold	Platinum
<b>Monitoring</b>						
Monitoring and proactive response for workstations	-	Included	Included	Included	Included	Included
Monitoring and proactive response for servers	-	-	-	N/A	N/A	N/A
Monitoring and proactive response for network equipment			-	-	Included	Included
Break\Fix support calls	Hourly	Hourly	Hourly	Hourly	Included	Included
Hourly & Project rate	\$ 105.00	\$95\h @ 15h Block	\$ 100.00	\$100.00	\$100.00	\$ 90.00
<b>Support Services</b>						
Onsite Support M-F 8am-5pm	Hourly	Hourly	Hourly	Hourly	Hourly	Included
Workstation Add - Move - Change	Hourly	Hourly	Hourly	Hourly	Hourly	Included
Remote Support	Hourly	Hourly	Hourly	Hourly	Hourly	Included
After Hours Support - 5:01pm-7:59am	\$110\h	\$110\h	\$110\h	\$110\h	Max 10 Hours\YR	Included
Workstation Patching & AV Patching	Hourly	Included	Included	Included	Included	Included
Remote Workstation Maintenance	Hourly	Hourly	Hourly	Hourly	Included	Included
Server Patching & AV Patching	Hourly	Hourly	Hourly	N/A	N/A	N/A
Onsite Server Maintenance	Hourly	Hourly	Hourly	Hourly	Hourly	N/A
Remote Server Maintenance	Hourly	Hourly	Hourly	Hourly	N/A	N/A
Network Optimization	Hourly	Hourly	Hourly	Included	Included	Included
Security Maintenance & Best Practices	Hourly	Hourly	Hourly	Hourly	Hourly	Included
Travel	Hourly	Hourly	Hourly	Hourly	Hourly	Hourly
<b>Security Firewall</b>						
Managed Security Appliance	Quote	5% Discount	5%	10%	12%	15%
Installation fees			Quote	\$699.99	\$599.99	\$499.99
<b>Minimum Agreement</b>		Carry over	30-day	6 month	6 month	1 year
<b>Implementation Fees</b>			\$199.99	\$279.99	\$349.99	\$399.99
Monitor agent & network monitor			Included	Included	Included	Included
Network scan & report			N/A	Included	Included	Included
Vulnerability & security report			N/A	Quote	Quote	Included
Environment documentation			N/A	Quote	Included	Included
<b>Managed Antivirus</b>						
Antivirus on all workstations			Quote	Quote	Quote	Included
<b>Monthly Rate</b>	Hourly	Min. 10 hour block	\$ 129.99	\$249.99	\$399.99	\$ 489.99

## Monitoring

### Monitoring and proactive response for workstations

As workstations are the primary equipment staff use, proactive monitoring provides alerts before issues arise. With this information our IT personnel can review these alerts to identify any concerns that may impact business operations, before they happen.

### Monitoring and proactive response for servers

A company's server is the heart of the organization, containing user information, company data, and business applications. Proactive monitoring for servers provides specific tailored alerts before issues arise. With this information our IT personnel can review these alerts to identify any concerns that may impact business operations, before they happen.

### Monitoring and proactive response for network equipment

Without the network, systems cannot communicate with each other. Data sharing and business applications cease to operate. With proactive monitoring for your network, our IT personnel monitor your IT infrastructure to insure any issues that may cause an outage can be reviewed and rectified before impacting your environment.

### Break\Fix support calls

All Break Fix support calls are covered under the Platinum Plan

### Hourly & Project rate

By choosing the Platinum Plan, any billable work outside the provided contract or project work is provided at a discounted rate.

## Support Services

This section will provide detailed information of the services covered in the Platinum Plan

### Onsite Support M-F 8am-5pm

All onsite break fix and proactive services performed Monday to Friday, 8am to 5pm are covered in the Platinum Plan.

### Workstation Add-Move-Change

All workstation additions, moves, and changes are covered under the Platinum Plan. This includes deployment of new desktop and laptops for employees.

### After Hours Support - 5:01pm-7:59am

All remote break fix and proactive services performed Monday to Sunday, 5:01pm to 7:59am are covered in the Platinum Plan.

### Workstation Patching & AV Patching

Insuring workstations are updated with the latest operational and security patches protects your company's systems and data. Provided with Workstation Patching is Antivirus Patching if applicable.

Patching is included in the Platinum Plan.

## Remote Workstation Maintenance

All remote support required for your company's workstations is covered under the Platinum Plan. This includes work provided responding to monitoring alerts and proactive maintenance.

## Server Patching & AV Patching

Insuring your company's servers are updated with the latest operational and security patches protects the system and the data it holds. Provided with Server Patching is Antivirus Patching if applicable.

Patching is included in the Platinum Plan.

## Onsite Server Maintenance

All onsite break fix and proactive services required for your company's servers performed Monday to Friday, 8am to 5pm are covered in the Platinum Plan.

## Remote Server Maintenance

All remote support required for your company's servers is covered under the Platinum Plan. This includes work provided responding to monitoring alerts and proactive maintenance.

## Network Optimization

Providing optimization services for the network keeps systems running at peak performance. Changes to network switches, firewall routes or policies are included in the Platinum Plan.

## Security Maintenance & Best Practices

Providing industry best practices related to security and vulnerability management is a component of the Platinum Plan. If patches or "fixes" related to software or hardware need to be implanted these services are included in the Platinum Plan. Recommendations will continually be provided to insure your company's systems are top notch.

## Travel

Travel costs are based on hourly rates of \$100/h.



## TERM

The term of this contract will be 6 months from Sept 1<sup>st</sup>, 2020 through Feb 28<sup>th</sup>, 2021 unless mutually agreed upon in writing by both parties.

At the end of the contract term, a report summary will be provided by JMT Solutions detailing support requests, security breaches, network availability, review of completed and current projects and other details as JMT Solutions deems pertinent.

## COST AND PAYMENT SCHEDULE

The monthly fee for the above-mentioned services as provided by JMT Solutions to the Township of Head, Clara, will be \$249.99.

In order to provide the services, a one-time fee of \$279.99 is charged with the first month. This one-time fee includes the setup of remote monitoring agents, and initial network scan and report.

Should the number of the Township of Head, Clara, and Maria's supported workstations, laptops, tablets, or servers increase the contractual cost will be subject to review by both parties.

Payment is due on the first day of each calendar month, commencing Sept 1<sup>st</sup>, 2020.

## ACCEPTANCE

I have read the terms and conditions of the Total Tech Care Plan above and agree to abide by the terms and conditions contained herein. I further attest that I have authority to bind the company for the purposes of this agreement.

X

\_\_\_\_\_  
Township of Head, Clara, Maria

X

\_\_\_\_\_  
James Marki - JMT Solutions

**Total Tech Care Plan selected:** \_\_\_Silver\_\_\_

**Monthly Cost-Plus HST:** \_\_\_\$249.99\_\_\_

**One-Time Setup Cost:** \_\_\_\$279.99\_\_\_

**Start date:** \_\_\_Sept 1<sup>st</sup>, 2020\_\_\_

**End\Renewal date:** \_\_\_Feb 28<sup>th</sup> 2021\_\_\_